

# COMPRESSED AIR | CHILLER & COOLING BEST PRACTICES

[airbestpractices.com](http://airbestpractices.com)

[coolingbestpractices.com](http://coolingbestpractices.com)

July 2021

24 **Measurement Principles for Compressed Air KPIs**

30 **The AICD is Back!**

42 **Vapor Compression Applied in Heat Pumps**

52 **Boston Hospital Cuts Chiller Energy Bills 33%**

56 **Ice Storage or Chilled Water Storage?**



# Berry



FOOD & BEVERAGE PROCESSING  
& PACKAGING MONTHLY FEATURE

16

## Making an Impact at Berry Global

### SUPPLEMENT INSIDE!

The Magazine for QUALITY & RELIABILITY in ENERGY & WATER EFFICIENT Chiller & Cooling Systems

CHILLER & COOLING  
BEST PRACTICES

[coolingbestpractices.com](http://coolingbestpractices.com)

Hospitals



The Atlas Copco logo is positioned in the top right corner of the page. It consists of the brand name "Atlas Copco" in a white, italicized serif font, centered between two horizontal white bars. The background of the entire page is a photograph of an industrial facility with large grey metal cabinets, blue protective sheeting, and stainless steel piping. A large blue diagonal graphic with technical drawings is overlaid on the bottom right portion of the image.

*Atlas Copco*

## Ready for 100% Quality Air?

You've spent years developing the perfect product and we bet oil or microorganisms were not part of the plan. Without putting the right equipment and testing in place, potentially harmful microorganisms can thrive in your compressed air system and damage the integrity of your products and processes. That's why we've developed a two-fold solution. First, a range of audits based around air quality that can be performed on any system. Second, prevention always beats cure! Our multi-level product and service offering guarantees dry, oil-free air that's matched to your budget and efficiency goals.

It's not just about your compressor – it's about the entire compressed air system working together to keep your production safe. Peace-of-mind is only a call or click away.



866-472-1013



[www.atlascopco.com/air-usa](http://www.atlascopco.com/air-usa)

**QUALITY, SAFETY & RELIABILITY FEATURES**

- 24 Measurement Principles for Compressed Air System KPIs**  
By Pascal van Putten, VPIstruments
- 30 The AICD Conference is Back!**  
By Roderick M. Smith, Compressed Air Best Practices® Magazine



**SUSTAINABILITY & ENERGY/WATER EFFICIENCY FEATURES**

- 16 Making an Impact at Berry Global**  
By Roderick M. Smith, Compressed Air Best Practices® Magazine
- 42 Vapor Compression Applied in Heat Pumps to Reduce CO<sub>2</sub> Emissions**  
By Drew Turner, Danfoss

**SUSTAINABILITY & EFFICIENT TECHNOLOGY NEWS**

- 6 Corporate GHG-Reduction News**
- 61 Compressed Air Technology**
- 63 Chiller & Cooling Technology**

**EVERY ISSUE**

- 4 From the Editor**
- 65 Advertiser Index**
- 65 The Marketplace | Jobs and Technology**

**SUPPLEMENT  
ON PAGE 39!**



*COVER PHOTO. This month's cover features the Berry Global headquarters in Evansville, Indiana.*

Compressed Air Best Practices® (USPS# 17130) is published monthly except January-February combined by Smith Onandia Communications LLC, 37 McMurray Rd., Suite 104, Pittsburgh, PA 15241. Periodicals postage paid at Pittsburgh, PA and additional mailing offices. POSTMASTER: Send address changes to: Compressed Air Best Practices®, 37 McMurray Rd, Suite 104, Pittsburgh, PA 15241.

Compressed Air Best Practices® is a trademark of Smith Onandia Communications, LLC. Publisher cannot be held liable for non-delivery due to circumstances beyond its control. No refunds. SUBSCRIPTIONS: Qualified reader subscriptions are accepted from compressed air professionals, plant managers, plant engineers, service and maintenance managers, operations managers, auditors, and energy engineers in manufacturing plants and engineering/consulting firms in the U.S. Contact Patricia Smith for subscription information at tel: 412-980-9902 or email: patricia@airbestpractices.com. REPRINTS: Reprints are available on a custom basis, contact Patricia Smith for a price quotation at Tel: 412-980-9902 or email: patricia@airbestpractices.com. All rights are reserved. The contents of this publication may not be reproduced in whole or in part without consent of Smith Onandia Communications LLC. Smith Onandia Communications LLC. does not assume and hereby disclaims any liability to any person for any loss or damage caused by errors or omissions in the material contained herein, regardless of whether such errors result from negligence, accident, or any other cause whatsoever. Printed in the U.S.A.

# FROM THE EDITOR



## Quality, Safety and Reliability

Which compressed air Key Performance Indicators should be measured and monitored? Where should measurements be taken? Pascal van Putten, from VPIInstruments, tackles this topic in his article, “Measurement Principles for Compressed Air System KPIs.” Held in Las Vegas in May, “The AICD Conference is Back!” was said so many times, it became the title of my article describing the safe and well-attended event for air compressor distributors – it was wonderful to be together again!

Hospitals cannot compromise on reliability and safety. Eddie Rogers, from tekWorx, writes about how an 800-bed facility, in the Boston area, cut their chilled water energy bill by 33% – without compromising these factors. “Ice Storage or Chilled Water Storage?” is the topic explored by Trane’s Paul Valenta. Choosing the right energy storage strategy is key to any system.

## Productivity, Sustainability & Energy Conservation

The monthly food & beverage industry feature article is on the impact Berry Global’s corporate engineering team is having on plant reliability and energy efficiency. During our interviews, team members described work being done on their compressed air and cooling systems. Their energy efficiency targets fall under their formal Sustainability strategy named Impact 2025.

Air-to-water heat pumps are much more efficient than fossil fuel-sourced solutions. So says Drew Turner, from Danfoss, in his article about new vapor compression technologies applied to heat pumps. “Free-Cooling Chiller Systems” is the title of the article supplied by Thermal Care’s Tom Stone. The day is coming when every plant will have conducted a system assessment evaluating the free-cooling opportunity.

Registration is Officially Open for the 2021 Best Practices Expo & Conference taking place November 2-4, 2021 – in the Chicago outskirts near O’Hare International Airport! Please mark your calendars and we hope to see you there.

Thank you for investing your time and efforts into *Compressed Air and Chiller & Cooling Best Practices*.

**RODERICK M. SMITH**

Editor

tel: 412-980-9901

rod@airbestpractices.com



Register at <https://cabpexpo.com>

COMPRESSED AIR BEST PRACTICES® EDITORIAL ADVISORY BOARD			
Industrial Energy Managers	Doug Barndt	Energy Manager	Danone North America
	John Bilsky	Facilities Maintenance	Gentex Corporation
	Bhaskar Dusi	Corporate Energy Manager	CEMEX USA
	Richard Feustel	Senior Energy Advisor	Leidos
	William Jerald	Energy Manager	CalPortland
	Michael Jones	Director Corporate Energy	Intertape Polymer Group
	Robert Kirts	GTS Energy Manager	Stanley Black & Decker
	Kurt Kniss	Energy/Reliability Engineer	Shaw Industries
	Leslie Marshall	Corporate Energy Engineer	General Mills
	Ethan O'Brien	Group Energy Manager	Klöckner Pentaplast
	Brett Rasmussen	Senior Utilities Engineer	Nissan North America
	Brad Runda	Director Energy & Utilities	Purdue University
Bert Wesley, Sr.	Principal-Industrial Plant Engineering Practice Leader	Woodard & Curran	
Compressed Air System Assessments	David Andrews	VP, Global Marketing & Communications	Sullair
	Steve Briscoe	President	Compressed Air Challenge
	Tilo Fruth	President	Beko USA
	Chris Gordon	President	Blackhawk Equipment
	Jan Hoetzel	General Manager	Airleader USA
	Paul Humphreys	VP Communications	Atlas Copco
	Phil Kruger	General Manager	Harris Equipment
	John Lucidi	Sales & Marketing Manager	Parker GSF Division
	Wayne Perry	Sr. Technical Director	Kaeser
	Eric Solverson	Vice President	Total Equipment Company
Derrick Taylor	Manager	PneuTech Products	
Jim Timmersman	Senior Auditor	Power Supply Industries	
Jeff Yarnall	Auditing Manager	Rogers Machinery	



## 2021 MEDIA PARTNERS



# The Best Choice for Breathing Air Systems: MBS Series

- Mikropor MBS Series Breathing Air Systems – All in one package
  - Oil removal coalescer
  - Water removal desiccant dryer
  - VOC and odor removal absorption unit
  - Harmful gases (including CO) removal absorption unit
  - Particle removal
- Fully Automated Operation
- 24/7 Breathing air production
- Air quality meets all relevant standards

**“United States Pharmacopeia  
USP Certificate”**



Please contact us for a Complimentary Consultation  
[support@mikroporamerica.com](mailto:support@mikroporamerica.com)

# CORPORATE GHG-REDUCTION NEWS\*

Featuring: Corning, Hexion, Pirelli, CalPortland, GSK, Koch Industries, CEMEX

\* Scope 1 and 2 GHG Emissions from Direct Operations

## Corning Named 2021 ENERGY STAR® Partner of the Year

Corning Incorporated (NYSE: GLW) announced, in April 2021, it has been named a 2021 ENERGY STAR® Partner of the Year – Sustained Excellence recipient by the U.S. Environmental Protection Agency (EPA) for continued commitment to energy efficiency.

“We’re honored to be named a 2021 ENERGY STAR Partner of the Year,” said Wendell P. Weeks, chairman and chief executive officer.

“We continuously strive to better our company, our communities, and our environment. Last year, for the first time, we announced 12 global sustainability goals, three of which highlighted our environmental commitments to energy, water, and waste management. In our ongoing commitment to sustainability, we look forward to achieving those goals, setting new ones, and continuing our partnership with the EPA.”

Partner of the Year is the EPA’s most prestigious award, with the Sustained Excellence designation reserved for companies achieving Partner of the Year status several years in a row and making continued improvements to their energy management programs. This is Corning’s eighth consecutive year earning Partner of the Year recognition and its sixth consecutive year achieving Sustained Excellence.

“ENERGY STAR award-winning partners are showing the world that delivering real climate solutions makes good business sense and promotes job growth,” said EPA Administrator Michael S. Regan. “Many of them have been doing it for years, inspiring all of us who are committed to tackling the climate crisis and leading the way to a clean energy economy.”

Corning launched its Global Energy Management program in 2006 to create

and execute effective energy strategies. The program has grown to include teams that implement energy- and water-savings projects at Corning facilities worldwide.

In its 2021 award application, Corning highlighted:

- Improving companywide energy productivity by more than 31% since 2006
- Continuing investment in renewable energy and ranking among the top 25 corporate solar energy users in the U.S. by the Solar Energy Industries Association
- Achieving the ENERGY STAR Challenge for Industry at eight additional Corning manufacturing facilities in 2020, for a total of 37 global sites

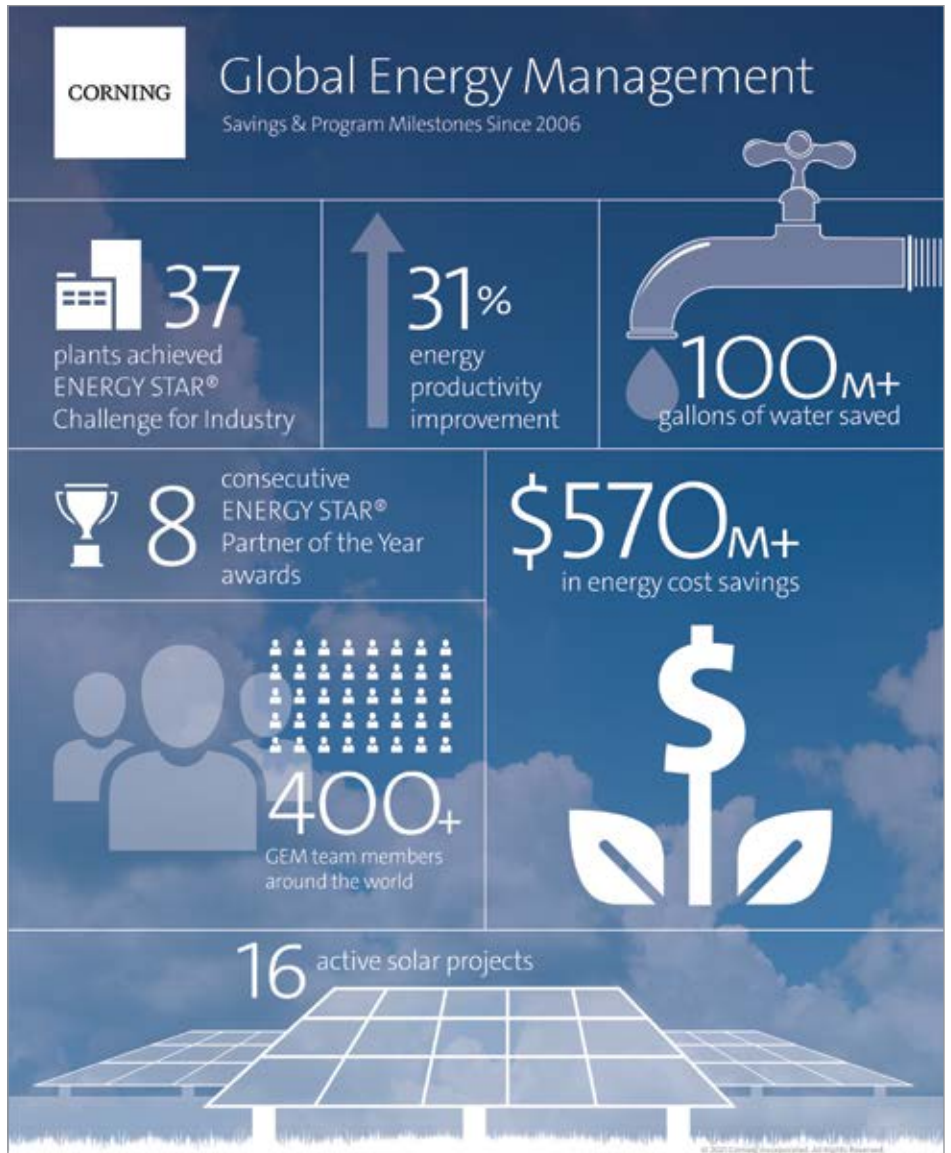

- Earning recognition from ENERGY STAR industrial partners as a 2020 Top Project winner for a water-conservation and byproduct-recycling project at Corning's Concord, North Carolina, facility
- Surpassing \$570 million in energy savings for the company since 2006

Corning is a part of a select group of businesses and organizations that achieved this award. For a complete list of 2021 winners and more information about ENERGY STAR's awards program, visit [energystar.gov/awardwinners](https://energystar.gov/awardwinners).

To learn more about Sustainability at Corning visit <https://www.corning.com/worldwide/en/sustainability.html>

### Hexion Announces Greenhouse Gas Emission Reduction Commitment

Hexion Inc. announced (May 2021) that in order to help address climate change, it has committed to reduce absolute carbon emissions by 20 percent by 2030. A leading producer of adhesives, coatings and composite resins, Hexion's commitment encompasses "Scope 1" and "Scope 2" emissions, which are direct and indirect greenhouse emissions from operations and consumed energy. The reduction target is compared to 2017, the baseline year of operations.

"Today's announcement is part of our ongoing commitment to further align our manufacturing operations with our strategic sustainability practices," said Craig Rogerson, Chairman, President and Chief Executive Officer. "Doing our part to address the significant global environmental challenges of climate change and resource scarcity is aligned with our company



**THE BULLETPROOF,  
BEEN-THROUGH-IT-ALL,  
TAKEN-SOME-BEATINGS,  
WORKS-ITS-BUTT-OFF,  
TOTALLY-TENACIOUS  
AIR COMPRESSOR**

THAT'S THE TRUE MEANING OF **DURABILITY**



EXPLORE THE BROAD RANGE OF NEW SULLAIR COMPRESSORS AT  
[SULLAIR.COM/INDUSTRIAL](https://SULLAIR.COM/INDUSTRIAL)



**SULLAIR**<sup>®</sup>

A Hitachi Group Company

© 2021 Sullair, LLC. All rights reserved. [SULLAIR.COM](https://SULLAIR.COM)   

## Corporate GHG-Reduction News

values of supporting the communities where we operate, and our associates live. In addition, our product portfolio is strategically aligned to support products with sustainable attributes, such as wind energy and composites for lightweight auto applications. Our ongoing commitment to new product innovation – coupled with manufacturing enhancements that support lower emissions – is expected to guide our long-term growth plans going forward.”

Hexion is also reviewing its “Scope 3” emissions, which are those associated with all other aspects of our business, such as raw materials, product use and disposal, waste generation, business travel, and the impact of associate commuting, among others. The establishment of the greenhouse gas reduction commitment follows a 2020 materiality assessment where Hexion engaged with various internal and external stakeholders. From that assessment, the Company determined its most important areas of focus, which included formalizing the following goals:

- **Minimizing climate change impact** – Hexion will strive to protect against climate change throughout its business lifecycle by efficiently using natural resources, optimizing existing processes and enhancing products and technologies through continuous innovation.
- **Developing innovative sustainable products** – Hexion is committed that by 2030, all new products will incorporate sustainable attributes.
- **Enhancing worker safety/well-being** – By 2022, Hexion will offer a voluntary well-being program that addresses associate physical, mental, and financial well-being with the goal of 50% associate participation in the program by 2025. Hexion also re-affirmed its commitment to continue to drive toward zero recordable injuries.
- **Reducing spills and releases** – Hexion has committed to reduce spill mass and releases by 80 percent by 2025.

## Presenting the 2021 Engineering Firm Webinar Series

Learn from Experts at Black & Veatch, Woodard & Curran and Jacobs with  
**FREE\* Live and On-Demand Webinars**

### Upcoming LIVE Engineering Firm Webinars

- **August 12:** Air Compressor & Dryer Sizing for High Ambient Temperatures – *Paul Baker, P.E., Sr. Mechanical Engineer, Jacobs*
- **November 18:** Precise Cooling Temperature Control Ensures Quality and Increased Cycle Counts – *Bert J. Wesley, P.E., Sr. Principal, Industrial Plant Engineering Practice Leader, Woodard & Curran*

### Library of Engineering Firm Webinars Includes

- Managing Cooling Tower Cycles of Concentration – *Nick McCall, P.E., Technical Manager, Woodard & Curran*
- Sorting Through the Menu of Aeration Blower Technologies – *Julie Gass, P. E., Lead Mechanical Process Engineer, Black & Veatch*

\*Included with your free magazine subscription

Get FREE Instant Access\* to Webinars >>> <https://airbestpractices.com/magazine/webinars>

BLOWER & VACUUM  
**BEST PRACTICES**  
blowervacuumbestpractices.com

COMPRESSED AIR  
**BEST PRACTICES**  
airbestpractices.com

CHILLER & COOLING  
**BEST PRACTICES**  
coolingbestpractices.com



- **Maintaining product stewardship** – Hexion remains committed to implementing the Responsible Care Product Safety Code and will continue to be transparent and communicate to key stakeholders regarding its stewardship programs such as risk reviews and reduction of substances of concern.

As further validation of its commitment to more sustainable operations, Hexion also recently received its first ENERGY STAR® Partner of the Year award, one of the highest honors bestowed by the United States Environmental Protection Agency’s ENERGY STAR program. Hexion was recognized for numerous successes in waste reduction and energy efficiency throughout the company since 2014. In that time, Hexion has reduced global energy intensity by 28 percent, executed more than 250 sustainability projects, and produced water and energy savings of approximately \$14 million, including \$2 million in 2020 alone. Each year, the ENERGY STAR program honors a group of businesses and organizations that have made outstanding contributions to protecting the environment through superior energy achievements. ENERGY STAR Award Winners lead their industries in the production, sale, and adoption of energy-efficient products, services, and strategies. These efforts are essential to fighting the climate crisis and protecting public health.

*Hexion also recently released its 2020 Sustainability Report, which details the Company’s current progress against these goals. The report can be viewed at [www.hexion.com/company/responsibility/sustainability](http://www.hexion.com/company/responsibility/sustainability).*

### CDP Reconfirms Pirelli a Leader in the Fight Against Climate Change

Pirelli & C. S.p.A. has been reconfirmed as a global leader in the fight against climate change earning a place in the Climate A list prepared by the CDP (former Carbon Disclosure Project), the international non-profit organization which gathers, distributes and promotes information on environmental issues.

The “A” rating, which is given to only a few companies of the thousands participating, is the highest score that a company can receive. It takes into consideration the effectiveness of the efforts made to reduce emissions and climate risks and to develop a low carbon emission economy, as well as the completeness and transparency of information provided and the adoption of the best practices associated with climate impact.



**hertz**  
KOMPRESSOREN

**CLEAN, OIL-FREE  
COMPRESSED AIR  
ISO 8573-1 CLASS-0**

ISO 8573-1  
**CLASS  
OIL-FREE**

SCROLL HS-30

**ONE OF THE BEST**  
SUPPLY PARTNER  
IN THE INDUSTRY

**CLASS 0**

**hertz**  
KOMPRESSOREN

**hertz-kompressoren.us**

# FREE SUBSCRIPTION

DIGITAL EDITION FREE WORLDWIDE  
PRINT EDITION FREE TO U.S. SUBSCRIBERS



Learn How To Save  
Energy & Improve  
Productivity In  
YOUR Industry!

Subscribe Now!



Subscribe at  
**airbestpractices.com**

## Corporate GHG-Reduction News

“The recognition of the CDP confirms once again our commitment to sustainable development through the fight against climate change. It’s what we try to do every day through our Research – developing processes and products that are always more sustainable, safer and better performing”, said Marco Tronchetti Provera Executive Vice Chairman and CEO of Pirelli.

The CDP, whose goal is to guide companies and governments to reduce hothouse gas emissions, protect water resources and forests, gathers data related to environmental impacts, risks and opportunities, for an evaluation independent of the methodology with which scores are calculated.

In 2020, over 515 investors, with assets of over 106 trillion dollars, and 150 large-scale buyers, with a buying power of 4 trillion dollars, called on companies to share these data through the CDP platform and over 9,600 companies responded.

The recognition from CDP confirms Pirelli’s constant commitment to questions of Sustainability, an area in which the company already boasts a number of achievements. They include world leadership in the Automobiles & Components sector on the Dow Jones World and Europe indices and the validation of targets for the reduction of CO<sub>2</sub> emissions by the Science Based Targets Initiative (SBTi). This one, in particular, is significant recognition that testifies the Pirelli’s commitment to achieving group Carbon Neutrality by 2030, underpinned by its goal of using 100% renewable electric energy by 2025.

To learn more about Sustainability at Pirelli visit <https://www.pirelli.com/global/en-ww/homepage>

## CalPortland® Earns 2021 Energy Star® Partner Of The Year Award For Seventeenth Consecutive Year

CalPortland® is proud to announce (April 2021) that it has received the 2021 ENERGY STAR® Partner of the Year – Sustained Excellence Award from the U.S. Environmental Protection Agency and the U.S. Department of Energy. This is CalPortland’s seventeenth straight Partner of the Year award.

“We are extremely honored to receive the 2021 ENERGY STAR Partner of the Year – Sustained Excellence Award,” said CalPortland President/CEO Allen Hamblen. “The ENERGY STAR program is a key component to CalPortland’s sustainability solutions. By creating a company culture centered around energy efficiency and the ENERGY STAR program, we continue to find solutions to reduce our energy intensity and carbon footprint.”

CalPortland has been an ENERGY STAR PARTNER since 1996 and remains dedicated to demonstrating and promoting energy efficiency within the company and to other companies in the construction materials industry. The 2021 national award is the seventeenth consecutive ENERGY STAR Partner of the Year Award for CalPortland, a feat that has never been matched by any other industrial company.

Since 2003, CalPortland’s energy management efforts have reduced the company’s overall energy intensity by 17 percent, avoiding over 3.3 million metric tons of CO<sub>2</sub>. This equates to removing more than 719,000 cars from the road annually. Key 2020 accomplishments include:

- Reducing the carbon footprint and embedded energy of its cement products by introducing **ADVANCEMENT™**, a low carbon cement.

- Investing more than \$45 million to upgrade on/off road vehicles to improve fuel efficiency; constructing the company's third compressed natural gas (CNG) station; replacing 24 diesel hauler trucks with CNG trucks using renewable natural gas; and conducting a test of a hybrid CNG/electric concrete mixer truck.
- Working with the leadership of the national cement, concrete, and asphalt trade associations to increase industry involvement in energy management and ENERGY STAR.
- Earning ENERGY STAR certification for the ninth consecutive time for the Rillito Cement Plant

- Incorporating strategic elements in the corporate energy program by using ENERGY STAR's cement plant certification, Challenge for Industry, and Treasure Hunt campaign.
- Promoting energy management best practices and increasing energy awareness through an innovative plant efficiency video series under CalPortland's "Energy in Industry" YouTube channel.

CalPortland Company is a major producer of cement, ready mixed concrete, aggregates, concrete products and asphalt in the western United States and Canada. Founded in 1891, CalPortland remains a leader in the industry through its commitment to quality, safety,

customer service, technical excellence and environmental leadership. The company maintains its headquarters in Glendora, California.

*For more information about CalPortland Company, visit [www.calportland.com](http://www.calportland.com)*

### **GSK announced as a Principal Partner of COP26 UN Climate Change Conference**

GSK was announced (May 2021) the COP26 Principal Partner for the pharmaceutical sector, building on the announcement of the company's new global environmental sustainability targets in November 2020. Alongside the delivery of global climate and nature targets, the life sciences sector can play



## **Sullivan-Palatek Distributors Bring Value to Customers**

**Compressed air systems can be complex; that's why our Distributor network is key to providing end-users with the best compressed air solution for their businesses.**

Advantages of purchasing a Sullivan-Palatek air compressor through our Distributors:

- » Appropriate product selection recommendations, including sizing and feature specification
- » Integration of all components of your compressed air system
- » Operating parameters adjustments, including pressure and modulation
- » Installation and electrical connection solutions
- » After-the-sale customer service and technical support

**To connect with your local Distributor, start here**  
<https://www.sullivan-palatek.com/contact-sales-directors/>

**To read about how our Distributors can benefit you**  
<https://www.sullivan-palatek.com/posts/SPI-Distributor-Advantage/>



*Dependable by design.™*

© 2021 Sullivan-Palatek, Inc.

## Corporate GHG-Reduction News

a leading role in addressing the health-related impacts of climate change, and this partnership provides an important opportunity to galvanize action across countries and organizations.

GSK Chief Executive, Emma Walmsley, said: “As a global science-based healthcare company, we want to play our part in helping protect and restore the planet’s health, in order to protect and improve people’s health. We know that taking actions to do so will make our business more resilient and support growth in the long term. We strongly believe that COP26 must accelerate global actions and collaborations to protect climate, nature and health and we are delighted to support the UK government with their ambitions for a successful COP26.”

As a Principal Partner, GSK will work closely with the COP26 team and the UK government to plan key climate and health focused events at the Conference, and on launching new initiatives in advance of November 2021 in support of COP26 and GSK’s environment and sustainability targets.

During the COP26 partnership, GSK will focus on several areas, including working alongside other leading health focused organizations to improve understanding and measurement of the impacts of climate change and nature loss on health. This will support improved health resilience globally, including as part of future pandemic preparedness, as we better understand how climate change and nature loss will impact disease burden and patient

need so that life science research can respond in the future.

GSK will also leverage its COP26 role to act as a catalyst for the life sciences sector on the Race to Zero, supporting collaborative action on supply chain scope 3 emissions. Through the promotion and development of low carbon medical treatments and new models of care we believe that industry can support healthcare systems transition to net zero and promote climate ambition directly with global networks of peers, supply chains and partners.

Environmental sustainability is a key part of GSK’s focused ESG approach to support the delivery of sustainable long-term business performance, reduced risk and increased social impact.

### Key GSK progress since November 2020

As part of progress toward the achievement of its renewed sustainability targets announced in November, GSK is already progressing significant contributory initiatives across its global business, including:

- From June 2021, GSK will invite proposals from potential partners for the development of nature-based carbon removal projects that can tackle climate change, promote biodiversity and improve public health outcomes. Partners will be announced in late 2021.
- On 13 May, GSK Consumer Healthcare, the world-leading consumer healthcare business, announced its commitment to make over a billion toothpaste tubes recyclable by 2025 as part of its ongoing sustainability journey. The company is partnering with two global packaging suppliers to launch fully recyclable toothpaste tubes across its specialist and science-based oral



health brands, including Sensodyne, parodontax and Aquafresh.

- At the White House Leaders Summit on Climate in April 2021, GSK was announced as a participant in the The Lowering Emissions by Accelerating Forest finance (LEAF) Coalition, an initiative with initial participation from the governments of Norway, the United Kingdom, the United States, and other leading companies including Amazon, Airbnb, Bayer, Boston Consulting Group, McKinsey, Nestlé, Salesforce, and Unilever. Participants will support high-quality emissions reductions from tropical and subtropical forest countries, enabling efforts to reduce and end deforestation. This initiative aims to mobilize at least \$1 billion in financing, kicking off what is expected to become one of the largest ever public-private efforts to help protect tropical forests, to the benefit of billions of people depending on them, and to support sustainable development.

**These initiatives are in addition to GSK's good progress on reductions in carbon and nature impact including:**

- A 32% reduction in scope 1 & 2 carbon emissions since 2017
- 68% of global electricity consumption now from renewable sources
- Zero waste to landfill across global operations
- Joining the UN Water Resilience Coalition

Find out more on GSKs Environmental Sustainability Commitments.

*GSK is a science-led global healthcare company with a special purpose: to help people do more, feel better, live longer. For further information please visit [www.gsk.com/about-us](http://www.gsk.com/about-us).*

### **Koch Industries Earns EPA 2021 ENERGY STAR<sup>®</sup> Partner of the Year Award for Energy Management**

At its more than 300 operations and production units in the United States, Koch companies create everyday essentials that help people improve their lives while working to use fewer resources. In recognition of this work, Koch Industries has earned the Environmental Protection Agency's (EPA) 2021 ENERGY STAR<sup>®</sup> Partner of the Year Award – the second time since becoming an ENERGY STAR partner. The award recognizes organizations that have

made outstanding contributions to protecting the environment through energy efficiency, and is the highest honor jointly bestowed by the EPA and United States Department of Energy.

Koch, an ENERGY STAR Partner since January 2015, maintained a high level of performance, improving energy efficiency in its businesses by as much as 1.5%. As a result of Koch's efforts to achieve best-in-class energy management program and practices, Koch received plant certifications in the top 25% of energy efficiency in the refining, fertilizer, and pulp industries. Koch demonstrated leadership in advancing energy management best practices not only through its operational performance, but also through collaborative knowledge sharing with ENERGY STAR, including activities during the COVID-19 pandemic.

## IDC Series

The Most Effective Active Molecular Filtration

- Best value proposition in the market
- Longest life in the industry
- Requires no electricity
- Maintenance free and mold resistant
- Disposable as non-hazardous special waste
- Comes in six sizes: 350 CFM – 2,000 CFM

MICRO

IDC

SMART-PAK

SUPER-PAK



**Clean Resources**

Condensate Management—Engineered for Life



1540 Louis Bork Dr. Batavia, IL 60510 • 800-566-0402 • [Sales@cleanresources.com](mailto:Sales@cleanresources.com)

## Corporate GHG-Reduction News



“At Koch, we continually innovate and transform our operations to make essential products using fewer resources, minimizing waste and reducing energy intensity in the process. Our recognition as ENERGY STAR Partner of the Year for 2021 is a testament to Koch employees’ commitment to stewardship and innovation that makes people’s lives better,” said Sheryl Corrigan, director of environmental, health and safety at Koch Industries. “For decades, Koch companies have spent billions of dollars and employees have devoted countless hours to constantly improve our energy efficiency. We will continue to seek new and innovative ways to promote stewardship through new technologies, processes and partnerships.”

The ENERGY STAR Partner of the Year Award is the latest recognition of Koch’s commitment to being a responsible corporate steward, following more than 1,300 safety and environmental awards worldwide since 2009.

Since 2015, Koch has invested more than \$1.5 billion in energy efficiency projects across Koch companies.

The ENERGY STAR award comes as Koch companies work toward even greater energy management and efficiency practices. While its

businesses have grown, Koch has experienced a 53% reduction in production-related waste since 2012 – a total of 527 million pounds – according to EPA’s Toxics Release Inventory Report. Of the waste produced and reported to the EPA at Koch facilities in 2019, 91% was recycled, recovered for energy or treated – a total of 415 million pounds.

*For more information about Koch’s stewardship work, please visit: [www.kochind.com/responsibility](http://www.kochind.com/responsibility). To read about Koch’s stewardship from Sheryl Corrigan, director of environmental, health and safety at Koch, please visit: [www.kochind.com/stewardship](http://www.kochind.com/stewardship).*

### CEMEX Paves the Road for a More Sustainable Future

CEMEX, S.A.B. de C.V. (“CEMEX”) (NYSE: CX) presented (March 2021) its Integrated Report 2020: “Safe. Essential. Resilient.” which includes a comprehensive analysis of CEMEX’s strategic vision, operational performance, corporate governance, and value creation at a global level. The report highlights the company’s response to the COVID-19 pandemic, the essential value of its industrial activity, its Climate Action strategy, and its commitment to drive the industry’s innovation by unlocking new value opportunities.

“2020 was undoubtedly a very challenging year, with COVID-19 abruptly upending every aspect of our lives and disrupting every industry worldwide. At CEMEX, that uncertainty and the challenges it posed brought out the best in our people. It also revealed the essential nature of our products and services, the value we bring to our customers, and the strength and resiliency of our business,” said Fernando A. Gonzalez, CEO of CEMEX. “Sustainability remains to be one of our top priorities, and our Climate Action strategy makes us confident in our ability to achieve our targets and aspirations.”

Among the main accomplishments presented in CEMEX Integrated Report 2020 are:

- CEMEX developed and implemented more than 50 strict hygiene and safety protocols to mitigate the risk of COVID-19 contagion throughout its worldwide sites and operations.
- CEMEX reached a low level of employee lost-time injuries (LTIs) for the sector and made progress across most of its countries, with 96% of its operations achieving zero fatalities and LTIs.
- CEMEX Go was instrumental in allowing customers and employees to work remotely with seamless efficiency and consistently, safely, and reliably deliver products despite the challenging circumstances. 61% of CEMEX total global sales were made digitally through CEMEX Go, with a 90% overall usage rate among recurring customers and high customer satisfaction levels.
- CEMEX announced its Climate Action strategy in February 2020, defining a global target of a 35% reduction of CO<sub>2</sub> emissions per ton of cementitious

products by 2030. To complement this strategy with a longer-term vision, CEMEX also established an ambition to deliver net-zero CO<sub>2</sub> concrete to all its customers globally by 2050.

- For its European operations, CEMEX reduced its net CO<sub>2</sub> emissions by close to 35% as of December 31st, 2020, and is the first company in the cement industry to define a 55% reduction target, in line with what the European Commission set as a new goal for all its member states.
- 91% of the company's cement plants co-processed a cumulative 2.7 million tons of waste as alternative fuels, allowing for approximately 1.6 million tons of coal replaced and a 25.3% substitution rate.
- Clean electricity now covers 29% of CEMEX global consumption in its cement business. In some countries such as the U.K. and Poland, renewable power covers 100% of local cement, concrete, and aggregates business needs.
- CEMEX globally introduced Vertua<sup>®</sup>, its low carbon and net-zero CO<sub>2</sub> products, a key milestone towards the company's 2050 CO<sub>2</sub> neutrality goal. Vertua<sup>®</sup> Ultra Zero is the industry's first concrete product with a Net Zero CO<sub>2</sub> footprint, and is already being used in relevant infrastructure and building projects around the world.
- To respond to market changes in outlook resulting from the pandemic, CEMEX launched Operation Resilience, a medium-term plan to improve operating results, margins and

promote growth, sustainability, and financial resilience.

- The company increased its financial flexibility with the successful amendment of its bank debt under its Facilities Agreement. This transaction underscores CEMEX's commitment to a carbon-neutral economy by incorporating green metrics and is one of the largest sustainability-linked loans in the world and the largest in emerging markets.
- CEMEX strengthened the Social Impact strategy that allows it to reinforce initiatives to contribute to communities' well-being. The company positively

impacted more than 23 million people on an accumulated basis, contributing to the U.N. Sustainable Development Goals (SDGs) achievement, particularly the five in which CEMEX can have the most impact.

CEMEX Integrated Report 2020 includes an external verification report carried out by KPMG and was prepared in accordance with the Global Reporting Initiative (GRI) Standards. To learn more about CEMEX Integrated Report 2020, please visit: [www.cemex.com/IntegratedReport2020](http://www.cemex.com/IntegratedReport2020)

*For more information on the company's Climate Action strategy, please visit: <https://www.cemex.com/sustainability/climate-action>*



**Zero Operating Cost  
Instrument Quality Air**

**SAHARA  
AIR PRODUCTS**

**Sahara Air Products**  
A Div. of Henderson Engineering Co., Inc.  
95 North Main Street  
Sandwich IL 60548  
800-544-4379 • 815-786-9471  
Fax 815-786-6117  
[www.saharahenderson.com](http://www.saharahenderson.com)



FOOD & BEVERAGE PROCESSING  
& PACKAGING MONTHLY FEATURE

# Berry

## Making an Impact at Berry Global

By Roderick Smith, Compressed Air Best Practices® Magazine

► Berry Global was established in 1967 as a small hometown company, based in Evansville, Indiana. Today it is still headquartered in Evansville but has grown to 48,000+ global employees and more than 295 locations. Generating \$12.6 billion in 2019 pro forma net sales, Berry Global creates innovative packaging and protection solutions.

Berry Global is a company which has grown through many acquisitions and now operate around 120 manufacturing sites in the U.S. Berry Global has over fifteen unique different plastic production processes. The processes will vary from plant-to-plant and, to name a few, include injection molding, blow molding, cast film, and blown film.

In February 2021, Chiller & Cooling and Compressed Air Best Practices Magazines interviewed members of the Berry Global Corporate Plant Engineering Team to gain an understanding of the work being done

to improve system reliability and energy efficiency. The team members interviewed were Chris Tedford (Director of Corporate Plant Engineering), Daniel K. Pemberton (Corporate Project Engineer), and Tyler W. Lyons (Corporate Plant Engineering Manager).

### Chris, what is the mission of the corporate engineering team at Berry Global?

We've had a Corporate Plant Engineering team for some time now and our primary objective is to help improve the reliability and efficiency of our manufacturing plant infrastructure and plant utilities. This means we cover a lot of ground including chilled water (cooling) systems, water treatment, compressed air, resin conveying systems, lighting, and electrical system safety and reliability. In our organization, some projects are plant led, where others require a very hands on approach with lots of onsite project management and some projects where we

mainly help with the initial scoping and justification to get it ready for capital approval.

The team is working to develop subject matter experts in key areas. Daniel Pemberton focuses on compressed air systems and Tyler Lyons focuses on chillers, cooling towers, and cooling systems in general.

Having grown by acquisition, we are well accustomed to the discovery process of bringing a new facility into our organization. Over time our plants have taken different approaches on how to expand their infrastructure systems to meet the needs of plant expansions. Many of the plants have added equipment to meet the needs of production, which has led to poorly optimized systems. Trying to drive consistency across our plants is a challenge we have taken on. Our team has done a great job of creating a centralized inventory of assets and using that to identify, prioritize, develop, and ultimately execute on these opportunities.



**Daniel, Can you describe the work being done with compressed air systems?**

Compressed air is a relatively new initiative, at the corporate level. The plants obviously have been managing compressed air for a long time.

Since Berry Global is the product of so many acquisitions that had different equipment preferences, maintenance schedules and practices, and capital reinvestment strategies; the first step has been to create an inventory of all compressed air system assets. For each entry in this database we track basic nameplate information, age, and how well it's been maintained. We enter every single asset into our inventory. This generates a risk score for each asset and then an overall risk score for the system as it relates to reliability and

energy. We are evaluating whether or not the system or any component, within the system, could have any impact on production in terms of downtime hours or making scrap product. The intent is also to identify some of the older and less efficient pieces of equipment. Through this study, we have learned that our average system size is in the 100 to 500 hp range at most plants.

**Are compressed air system assessments and leak audits conducted regularly?**

Absolutely. We have had supply-side compressed air audits performed, within the last three years at around forty percent of our plants. For the most part, audit results will remain quite accurate for us over a three-year period. We have done fewer demand-

side audits, but we do perform leak studies frequently. Roughly one third of the plants do annual compressed air leak studies (and repair) while another one third has done one within the last 3 years. With the final one third of plants, they have either not done one or it hasn't been documented.

We believe there is a 5-15% leak rate opportunity at most sites. We estimate that plants who are not conducting annual leak studies have even larger opportunities. Ultrasonic leak detectors are the identification and verification tools we use to find leaks and verify that they are fixed. We work with a couple companies for most of our leak studies, but we also use local (to each plant) compressed air distributors.

# SMART-GUARD-D-LUX

## Electronic zero air loss drain



for hospital applications

with ANTI-BACTERIAL build-up feature for compressed air systems

- ANTI-BACTERIAL BUILD-UP (BIO) FEATURE - FOR HOSPITAL APPLICATIONS
- N/O AND N/C - ALARM (POTENTIAL FREE RELAY) STANDARD INCORPORATED
- ANTI-AIR-LOCK-SYSTEM
- HIGH PRESSURE VERSION ALSO AVAILABLE



CONDENSATE DRAINS



**POD-TD**  
Pneumatic level sensed



**MAG-11 - with test button**  
Magnetic level sensed



**SMART-GUARD-MINI-AL**  
Electronic zero air-loss - with alarm

OIL/WATER SEPARATORS



**SEPREMIUM RANGE**  
Oil/Water Separators

AIR SAVING PRODUCTS



**LOCATOR-EV**  
Ultrasonic Air Leak detection



**AIR-SAVER 1' & 2'**  
Air leak lock-down



JORC Industrial LLC • 1146 River Road • New Castle, DE 19720  
Phone: 302-395-0310 • info@jorc.com • www.jorc.com

THE CONDENSATE MANAGEMENT SPECIALIST

## Making an Impact at Berry Global



An air compressor room with single-stage rotary screw air compressors and refrigerated compressed air dryers.



An air compressor room with centrifugal and two-stage rotary screw air compressors.

Our leak study approach varies because some plants doing them get an energy rebate from a local utility which has a formal verification process to qualify for the rebate. Every rebate process is different. On studies not tied to a rebate, typically the goal is to have them all fixed within a one to three month time period. For example, we had one plant realize a reduced leak rate from 1,200 to 300 cfm!

### Besides leaks, what are some of the common compressed air optimization projects?

The opportunity for optimization is different at all of our plants. Generally, we are looking for a ten to fifteen percent energy savings from most of the projects we identify and execute. What type of compressed air project depends upon each situation. Here are a few recent examples.

1. Centralization of assets: we have a prospective project where two large oil-free centrifugal air compressors could replace eighteen (18) smaller oil-flooded rotary screws.
2. Using an existing waste stream to drive an air compressor. We are currently considering using steam and putting in a turbine to drive a centrifugal air compressor.
3. Recognize part-load situations and install master controls at plants or install single trim variable speed or variable displacement rotary screw air compressor. The unload energy is what we are working to eliminate with these types of projects.
4. We have a handful of plants which do require much higher installed horsepower to keep the plant running.

For these large, complex systems, control optimization is the focus. In 2020, we put a compressed air management system into one of our largest U.S. plants. It's a unique plant which has two buildings connected with a piping header, making control of 14,000 cfm of compressed air very difficult. The production lines at this facility use much more air than the average, causing 2,000 cfm swings in demand when they kick on! The result of the project was exciting as we were able to completely shut-off 800 horsepower of air compressors – really helping us with our annual energy efficiency goal!

### Do you provide the plants with any compressed air training or education?

Do you mean aside from reading your magazine!? Yes, our corporate energy team has been driving an initiative to sponsor Compressed Air Challenge training for maintenance and technical managers in our plants. We've had about sixty participants and think it is excellent training. I (Daniel Pemberton) have completed both Level 1 and Level 2 training. We want to continue doing this and know it has helped develop many projects, some of those just mentioned came from a Compressed Air Challenge attendee.

Our Director Continuous Improvement, Energy, Sustainability sends out a daily email to technical contacts with a success story

or highlighting Best Practices. Our team also publishes a monthly metrics, which scorecard some of these metrics at the sites and highlights successes. These are great opportunities for feedback and conversation starters around energy reduction.

**Thank you Daniel.**

### Tyler, can you talk about your work with chillers and cooling systems? Cooling is critical to injection molding isn't it?

You bet, our simplified business model is to melt plastic and cool it back into the form we want – and cooling water makes this happen. We need to optimize chilled water temperature and flow to ensure that our production



## CRITICAL RENTAL SOLUTIONS

### Temperature Control Solutions

- Air and Water Cooled Chillers to 1500 tons
- Open and Closed Loop Cooling Towers to 1000 tons
- Shell/Tube and Plate/Frame Exchangers to 3000 gpm

### Why Choose Critical Rental Solutions?

- Keep your facility operational in every season
- Reduce capital expense and optimize operations
- Minimize seasonal limitations
- 24/7 Service and Remote Monitoring



Call: 1-888-RENT-AIR (1-888-736-8247) | Visit: [www.criticalrental.com](http://www.criticalrental.com)

## Making an Impact at Berry Global



An air compressor room with water-cooled centrifugal and variable-speed rotary screw air compressors.



An adiabatic chiller helped saved 10 million gallons of water annually at a Berry Global plant.

machines make consistent finished products. In molding application, we cool the plastic through conduction and convection directly. Blown film is different in that cooling-water cools the air and then an air handler cools the plastic.

My (Tyler Lyons) primary focus has been on cooling water systems. Our number one priority is to improve the reliability and consistency of the manufacturing of our products, so we look at how chillers and water treatment can affect that. Again, we started with creating an inventory and knowledge of the assets in our portfolio. We currently operate an inventory over 600 chillers in North America. Most are in the 100 to 400 ton range.

Our first measure of reliability is chiller age. We have 67 chillers built pre 1995, which is beyond typical ASHRAE recommendations. We are becoming more proactive by looking at whether we have redundancy in the system, and working towards a short and long-term plan if we do not. If the units are air-cooled, or there are other inefficiencies, we know there might be an opportunity to save energy so we are also measuring the current energy efficiency to make a baseline.

### Can you describe some of the work being done with cooling water systems?

Sure thing. Our 2021 goal is to identify 10,000,000 kWh of energy savings from the cooling systems related to our chilled water systems. Understanding the applications in our plants has really helped us to optimize current systems and help us improve both reliability and efficiency. Here is a listing of projects and areas we are looking at.

1. Combining air-side and water-side economizing in film plants when we replace chill water equipment.

At a plant outside Charlotte, we had the chance to replace 6 air-cooled chillers past 25 years of age. They were supporting five separate cooling systems for blown film and cast film applications and providing them all with 45°F. Future design separates it into a blown loop and a separate cast loop at different optimal temperatures. By breaking out the cast film load we are able to increase project savings from 1.7M KWH/year to 3.7M KWH by adding waterside economizing to that loop. For the blown film loop, since we're already pulling in outside air, we automatically gain the benefit of free cooling on that system. The new system design utilizes four screw compressor water-cooled chillers.

- Free-cooling with both air and water-cooled chillers. This can work where we have consistent cooling load requirements like in injection molding, blow molding, thermoforming and cast film processes. Obviously, this works in plants with a conducive outdoor climate and also where we may already have control systems in place.
- We take Berry's "Always Advancing" into our approach for identifying and executing O&M opportunities to maximize equipment lifetime and improve energy efficiency. We are teaching sites how to evaluate their systems and realize quick wins. Our teams are adding water filtration, adding air filters to air cooled

equipment, cleaning condenser coils, adding corrosion inhibitors and biocides, and matching temperature setpoints to process requirements.

- Condenser relief on water-cooled chillers is an opportunity. The idea is a chiller works on the temperature difference between chiller water and cooling tower water. If you can lower the water temperature coming from the cooling tower, you lower the energy consumed by the system. Running the fan faster on the tower can do this. Vendors often provide efficiency numbers at lower cooling tower temperatures. To achieve this, we use improved fan control methods that rely on the outside wet bulb temperatures.

## Olive oil is good for you. Compressor oil is not.

**Protect your products, your packaging, and your reputation!**

**"Class Zero Oil-Free Air"**  
All models meet ISO 8573-1 Class 0  
for oil aerosol, liquid vapor and silicone

**Premium Efficient, OIL-FREE  
Rotary Screw Air Compressors**

**ROGERS  
KNW SERIES**  
ROGERS MACHINERY COMPANY, INC. - PORTLAND, OREGON, USA

Powered By  
**KOBELCO**  
Oil-Free Screw Technology

Proudly made in the U.S.A.



Rogers Machinery Company, Inc.  
**knw-series.com | 1-800-394-6151**

# FREE SUBSCRIPTION

DIGITAL EDITION FREE WORLDWIDE  
PRINT EDITION FREE TO U.S. SUBSCRIBERS



Learn How To Save  
Energy & Improve  
Productivity In  
YOUR Industry!

Subscribe Now!



Subscribe at  
**airbestpractices.com**

## Making an Impact at Berry Global

5. We did a great water savings project, in Iowa, where we will save 10 million gallons annually. The project eliminates single-pass cooling and replaces it with an adiabatic cooler. We selected an adiabatic cooler instead of a dry cooler because it will spray water on the cooling fins, creating some evaporation to lower the supply temperature beyond that of an equivalent dry cooler. This was kind of a one-off project because we do not have many single-pass cooling applications; most have been eliminated from our processes.
6. Water treatment is important for maintaining assets like molds and preventing corrosion. We typically rely upon a few preferred water treatment vendors to maintain safe

water and clean heat exchange surfaces. We consider any cooling tower not realizing at least 4 cycles of concentration an opportunity to reduce water usage. In some cases, we are trialing alternative treatment options and finding the results are comparable to traditional water treatment.

### Do you have energy dashboards at the plants?

Some of our sites have energy dashboards but most sites are still going back to the utility room to check gauges or localized PLC control systems. Systems used varies widely when we look at process cooling automation. In compressed air systems, we have some master controls but most systems do not. We don't mandate or require dashboards. We do see this happening, long term, for all plant utilities.



*A pump skid for a chilled water system.*

**Does Berry Global have energy efficiency targets and goals?**

Yes, these targets fall under our formal Sustainability strategy named Impact 2025 (visit <https://www.berryglobal.com/sustainability/environment>). Impact 2025 strategies identify three key areas to focus on and energy efficiency falls under the 3rd area – minimizing our operational impacts.

1. Optimizing the Design and Sustainable Sourcing of our Products
2. Engaging Partners to End Plastic Waste and Limit Global Warming
3. Minimize our Operational Impacts (normalized for production) in three areas:
  - a. Climate Change: reduce greenhouse gas emissions 25% by 2025 vs. the Company's 2016 baseline
  - b. Continuous Improvement: reduce landfill waste 5% per year and reduce energy and water consumption by 1% per year
  - c. Operation Clean Sweep®: prevents resin loss and implement this at acquisition sites within the first year

As you can see, our goal is to reduce water and energy intensity (energy and water consumed per pound processed) by 1% per year as part of our continuous improvement efforts.

**Is the Company meeting the Impact 2025 energy and water intensity goals?**

Although Impact 2025 provides near-term energy and water reduction goals, we have a long-term vision to be “Best in Class” in energy and water efficiency as part of our efforts to achieve Operational Excellence. Between 2018

and 2019, we reduced our energy intensity from 1.76 MWh per Metric Ton produced to 1.64 MWh/Ton. In 2020, our energy intensity initiative was negatively impacted by COVID-19 and our ongoing light-weighting efforts. Our energy intensity for 2020 was 1.65 MWh/Ton. Despite the headwinds in 2020, we are prioritizing energy reduction and expect to resume our previous trend of improvement moving into the future.

As a corporate engineering team, a large initiative of ours is to identify, prioritize and support the projects which will save 100

million kWhs annually – including O&M (Operations & Maintenance) projects. There are four (4) operational divisions and each has their own energy and water efficiency target. One of our most exciting multi-divisional initiatives, for example, has been DC to AC conversions with VFD on extruder motors.

**Thank you for sharing the way Berry Global is making an “Impact”!** BP

*For more information about Berry Global visit <https://www.berryglobal.com>*

To read similar **Plastics Industry** articles visit <https://airbestpractices.com/industries/plastics> or <https://coolingbestpractices.com/industries/plastics-and-rubber>



**ENERGY EFFICIENCY**  
**AirSmart**

## The Next Step in Compressed Air Energy Saving

Taking industrial energy efficiency to the next level

**Cost-saving:**

- Eliminate peak power charges
- Improved uptime
- Reduced operational costs
- Lower compressor maintenance costs

**Space saving:**

- Underground storage up to 600 PSI
- Safer than above-ground
- Saves manufacturing space/land costs

**Environmental:**

- Food safe applications (NSF)
- Use for oil-free, rotary or PET
- Nitrogen ready



OSHA NSF ASME Certified



**Proven:**

- 100% performance guaranteed
- Over 10 million KWH saved

Optimize, streamline & safeguard your factory's compressed-air process

Available now in the USA at [www.aug-wind.com](http://www.aug-wind.com)  
442.291.9730 • [augwindusa@aug-wind.com](mailto:augwindusa@aug-wind.com)



# Measurement Principles for Compressed Air System KPIs

By Pascal van Putten, CEO, VPInstruments

► It is a known fact that roughly 15% of the electrical energy absorbed by air compressors is converted into compressed air. The other 85% is lost as heat. Despite this low efficiency, compressed air is still a very popular utility in many industries. Compressed air system users are faced with challenges to get the best possible efficiency and to reduce the associated costs (energy, maintenance) as much as possible. Therefore, monitoring the right set of KPIs is nowadays a must-have for any energy manager or plant owner. In this article we clarify how the main KPIs can be monitored, and we will have a closer look at a few key KPIs: efficiency, pressure loss and leakage.

Key Performance Indicators (KPIs) are variables or measures by which the performance of organizations, machines and/or processes can be measured and analyzed in a targeted manner. For example, a KPI can be a certain production number per time unit, but also the amount of profit a company makes on a specific product.

A KPI dashboard is like a simplified cockpit for a pilot of an airplane. It provides the right information on time, on which you can rely when making decisions. For example: if overall system efficiency is off, you can take a closer look into the settings of your master controller. If consumption is significantly higher than normal or you see a pressure event, you need to look at your production lines or talk to operators in the plant. If dew point is off, fix/service the dryer or check if it is properly sized. For each issue there are many solutions and the KPIs will tell you soon if the implemented solution was right. Even more, KPIs can be used to calculate ROI on a future investment. In this way they will help to predict your future compressed air related energy costs.

For compressed air systems, some important KPIs are:

- Efficiency
- Dew Point
- Leakage rate
- Pressure loss
- Cost per product/part produced

Specific power (efficiency), leakage rate and pressure loss are a good starting point for any compressed air system, so this article will zoom in further on these three KPIs: What influences them, how you can measure them, and how to interpret them.

## KPI: Specific Compressor Power/Efficiency

The specific power of an air compressor is the ratio between compressor output (the amount of compressed air produced) and power consumption of the compressor. So, the KPI is calculated by input power divided by output flow, expressed in kW/100 cfm or kW/m<sup>3</sup>/min.

Specific power is important in the following situations:

- **Asset management:** when efficiency starts to deviate from initial situation, this can be seen as an early warning sign (e.g., need for a filter change on a centrifugal machine or internal fouling of heat exchangers).



- **Air over the fence:** In these contracts, efficiency is an important part of the deal. The compressor needs to deliver a pre-determined X amount of air for a Y amount of electric power.
- **Compliance:** Permanent monitoring is becoming increasingly important worldwide to achieve environmental and CO<sub>2</sub> reduction targets. In this context governments also play a crucial role with legislation such as Title 24 in California and the Energy Efficiency Directive in Europe.
- **Acceptance testing:** when testing a compressor in a lab (ISO1217).
- **Control system optimization:** The efficiency a given set of compressors controlled by a master controller, should match industry benchmark average.

**Total Compressor Station Efficiency vs. Individual Machines**

When the budget for instrumentation is limited, you can use one flow meter to monitor all compressors. This involves measuring the power consumption per compressor and measuring the flow on the main pipeline, i.e., after the dryers and the buffer tank. The advantage of placing the flow meter on the main line is that the actual compressed air consumption of the plant is also monitored. This information can be used to determine leakage and to create a “fingerprint” of the air demand using a histogram function.

In this scenario, it is important to calculate the average consumption over sufficient time, and divide this by the average power consumption, as loading/ unloading will cause fluctuations in the KPI. Modern energy management platforms can refine this further, by splitting up “load” power consumption, “unload” power

consumption and dividing this by the flow in a proper way. We recommend plotting efficiency as a function of air demand, to see if your system is running optimally.

To get a more granular insight needed to optimize compressor controls, flow should be measured per compressor. Pay special attention to flow meter selection and installation due to the harsh conditions in the discharge pipe of the compressor.

**Total measurement uncertainty. Propagation of errors. Boring subject?**

Total measurement uncertainty. Propagation of errors. For many of us these are subjects we leave to mathematicians. However, they are of extreme importance when looking at measurement data. Particularly when it

comes to the large investment decisions for air compressors, this topic should not be underestimated, and great care must be taken when comparing efficiency numbers.

Therefore, when monitoring efficiency, it is important to determine which accuracy level is acceptable. The required accuracy level depends on the application and on the size of the installation. The schematic below shows a (simplified) relational map between all parameters that are involved, just to get an idea about the complexity of efficiency measurement in volumetric (i.e., piston, screw, scroll) compressors. In the ISO1217 directive, one can read more on this topic and find other directives which tell you how to interpret results, confidence intervals, which type of flow meters must be used, and so on.



**Air System Products**  
Filtration Group®  
Making the World *Safer, Healthier & More Productive*

# Robo-Drain

## Zero-Loss Condensate Drains

Fully automatic, zero-loss drain protects compressed air systems without electricity. Translucent reservoir for visual assurance of operation and non-clogging, full port drain valve.

BULLETPROOF DESIGN BACKED BY INDUSTRY LEADING WARRANTY



RD750 RD11-T



[www.airsyspro.com](http://www.airsyspro.com)  
716.683.0435  
[ASPSalesTeam@AirSysPro.com](mailto:ASPSalesTeam@AirSysPro.com)

## Measurement Principles for Compressed Air System KPIs

The total measurement uncertainty of any measurement is defined as the statistical variation of a measured quantity. For further reading on this matter, we refer to the “GUM” (Evaluation of measurement data – guide to the expression of uncertainty in measurement, 2008).

### Systematic Errors and How They Propagate

Each measured signal has its own uncertainty. Now what is the effect of a systematic error on the measured efficiency? Let us look at a simple example. We want to check the efficiency of a 44 kW machine, running full load. We used a power meter ( $\pm 1\%$  reading),

and a flow meter ( $\pm 5\%$  reading). What is the maximum error of the efficiency?

As Table 1 shows, taking systematic errors to the extremes, the observed efficiency can be 16.6, 17.6, or 18.7 kW/ 100 SCFM. This is  $\pm 6\%$ . Now suppose the compressor manufacturer tested the 250 CFM compressor, the allowable deviation of efficiency is also 6% (See CAGI sheet). Worst case, you could have purchased a compressor which has a -6% deviation on output flow. When measuring this with an insertion probe ( $\pm 5\%$ ) you should be careful not to jump to the conclusion that the compressor is wrong, or the flow meter is right and vice versa.

What is the effect of a wrong efficiency number on the perceived annual costs? In this example, at a cost of \$0.06/kWh and 8760 annual running hours, the “money tolerance” is  $\pm 1400$  USD annually for this compressor. This may have an impact on your decision making: Any (major) decision based on less than  $\pm 1400$  USD energy savings could be based on systematic errors, so it might be a “wrong” decision. If this were an altitude meter of an airplane, and you were the pilot



Compressed air system KPIs help to track and improve the performance of your system.

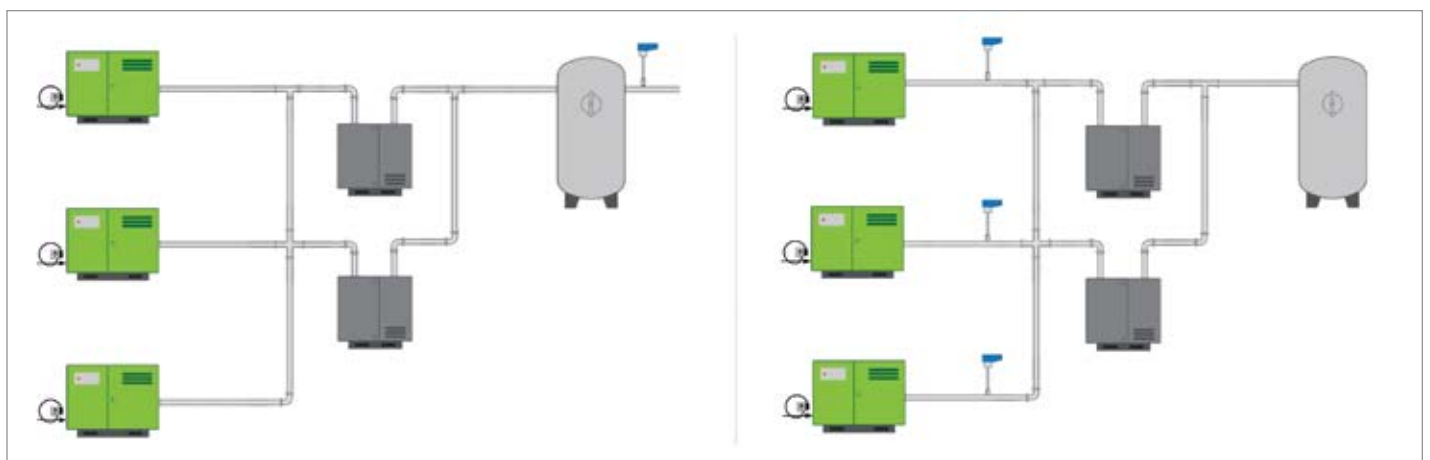

Depending upon goals, one can monitor the efficiency of the entire air compressor room, including air treatment equipment, or the efficiency of each individual compressor.

flying that plane... what would you do when the altitude meter is +/- 140 feet accurate? You probably want to stay at 280 feet minimum (2 x the error). And this also applies to making decisions for this compressor; if the projected costs due to poor efficiency will exceed 2800 USD/year it is time to do something.

**How to Take Measurement Errors into Account**

Most important is to be honest and transparent that there are always errors to be considered. Should you always invest in the most accurate measurement equipment? Well yes, if you need to verify the output according to ISO1217. It is even recommended to hire an external expert in such a case, as there are many more parameters to look at than just flow and power. When trending efficiency, a systematic measurement error is acceptable. You can see change of efficiency over time and monitor if a service job had the desired effect. In these cases, relative numbers are compared, not absolute numbers.

What always is important, is that the sensors are maintained properly and that they keep long term stability. The sensors should be stable for a time which exceeds the time with a factor of ten (rule of thumb) to be able to see the difference in efficiency caused by system degradation. So, when 5% degradation of your assets takes one year, the drift of the sensors should be less than 0.5% per year. Care should be taken when flow sensors are exposed to humid and dirty air, which may foul or clog the sensor. This can shorten the maintenance interval of the sensor.

Installation effects are also important to consider. Some technologies, like insertion probes and vortex meters, need specific pipe runs to be accurate. Other technologies can be prone to vibrations and pulsations in the flow.

	MAX. READING	NOMINAL READING	MIN. READING	UNIT
Flow	262.5	250	237.5	SCFM
Power	43.6	44	44.4	kW
Efficiency	16.6	17.6	18.7	kW/100SCFM
Error	-6%		6%	

Table 1.

These things all combined can have a dramatic impact on the measurement uncertainty, which exceeds the stated accuracy of 5% and therefore, in the field, it is often challenging to meet the requirements of ISO1217. We have also seen cases where an orifice flow meter was wrongly programmed, resulting in a 30% error on the efficiency number. This was a simple human error making a dramatic impact on the relationship between manufacturer and end customer.

**KPI: Pressure Loss**

Another critical KPI is pressure loss as low system pressure may cause machines and components powered by compressed air to stop. To monitor the pressure level, it is therefore important to measure at different locations in the plant. Especially when the compressed air distribution piping network has been expanded over the years and/or pipes are being used that are too small. Therefore, it is advisable to install pressure/flow meters

## Grade D Breathing Air Solutions



**CO-Guard**  
CO airline monitor



**ProAir 220**  
Four gas airline monitor



**AFS-50**  
Air filtration system



**AirGuard**  
Portable breathing air system

Protect and Refresh Your Breathing Air



Creative Gas Detection Solutions

800-521-2978

www.enmet.com

## Measurement Principles for Compressed Air System KPIs

at the beginning, middle and end of your compressed air piping system.

Production downtime is always costly and this is why the system pressure is often set at a (too) high value, just to be on the safe side. However, bear in mind that with positive displacement air compressors, each bar (14.5 psi) that the pressure rises, the energy costs will increase by 7%. We still see today that when pressure problems occur at the

machine level, an air compressor is often added to boost the compressed air capacity and pressure, which further increases (energy) costs. Pressure problems, however, can often be solved within the compressed air network itself by optimizing pipe diameters, installation of receivers and limiting flow to certain areas which don't need it. Notorious points of pressure loss are filters. Not replacing filters on time will cause an increasing pressure drop due to their ever-increasing resistance.

To be able to make a reliable analysis, flow measurement in combination with pressure measurement is the appropriate way. This makes it easy to determine exactly where pressure losses occur and how great these losses are. Pressure losses can be caused, for instance, by pipes that are too small (creating a high velocity) or by excessive flow consumption. Consider "multivariable" flow meters as they provide a pressure signal by design.

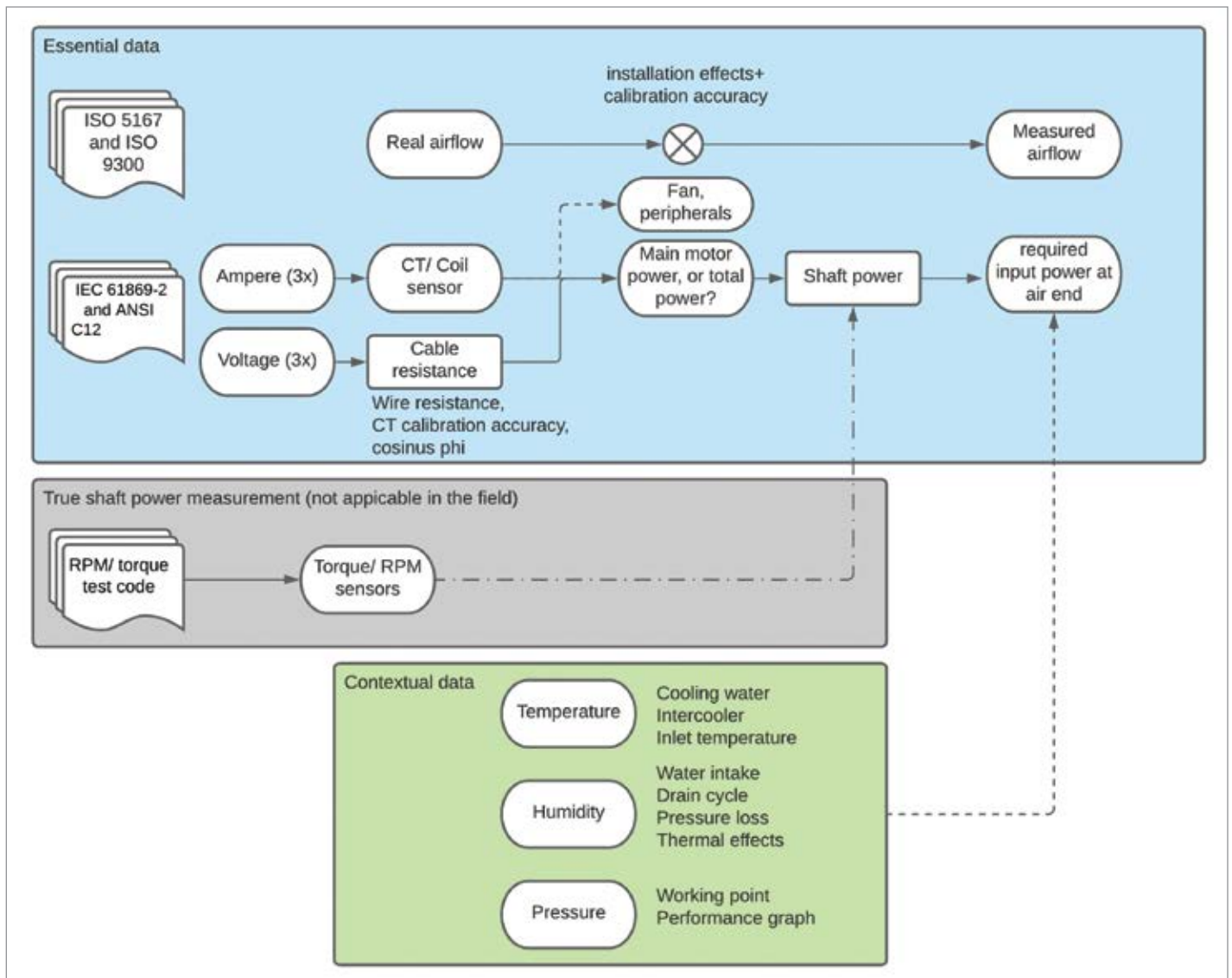

Figure 1. Relational flow diagram showing how the efficiency of a volumetric compressor should be measured. The diagram shows all parameters which are involved and how they influence the measured efficiency.

**KPI: Leakage**

Leak detectors are great tools to find compressed air leaks, but they still require a person to walk around the plant. One of the simplest ways to determine leakage percentage, is to look at the compressed air usage and/or flow rate at times when the plant is not operating and divide this on the average production flow. For example, during lunch breaks, after work hours and over weekends. Modern energy management software has built-in detection algorithms which calculate this automatically, so you can take your lunch break without having to look.

$$\text{Leakage} = \frac{[\text{Total flow during downtime}]}{[\text{Total flow during production}]} * 100\%$$

It also makes sense, for example, to compare the airflow before and after maintenance work is carried out, so you can see the financial result of a repair action instantaneously. Multiply leakage by total running hours and costs, to project the total costs of leakage on an annual basis.

Since leakage percentage is a relative number, the absolute accuracy of the flow meter is less important. As long as you have a stable and reliable sensor with a linear signal output, you can always calculate the percentage. The absolute value is irrelevant if the sensor is stable. A four percent (4%) reduction in flow on the main header means a 4% energy reduction, if the master controller can keep the compressors running at the same efficiency level. Also, the dynamic range of the flow meter is important, which is why vortex flow meters and differential pressure meters should not be

used for this application. Thermal mass has a superior range ability which enables to detect leakages properly.

**Conclusions**

When monitoring KPIs, the required sensors and sensor accuracy depends on the application. It is important to understand the effect of sensor accuracy on the calculated KPI, to interpret them properly. When selecting sensors, you need to know their influence on the total error budget, to make the right choice. For some KPIs like leakage percentage, the absolute accuracy of a flow sensor is of less importance. Also, thermal mass flow meters are more suitable for leakage monitoring compared to differential pressure or vortex meters. An advanced monitoring system can help with automatic calculations and alarms when KPIs start to deviate from target levels. **BP**

**About the Author**

*Pascal van Putten is CEO and founder of VPIstruments. He studied Mechanical Engineering at Delft University of Technology and has 20 years of experience in flow measurement, compressed air monitoring and industrial energy management.*

**About VPIstruments**

*VPIstruments offers industrial customers easy insight into energy flows. Founded in 1999, it provides complete solutions for monitoring compressed air flow, gas flow and electric energy consumption. Its products can be found all over the world and in a wide range of industrial markets, such as automotive, glass manufacturing, metal processing, food and beverage and consumer goods. For more information visit [www.vpinstruments.com](http://www.vpinstruments.com)*

To read similar articles on **Compressed Air Measurement** visit <https://www.airbestpractices.com/technology/instrumentation>

# Don't Get Left Behind – Get Certified!

Are you an expert in the compressed air industry? Holding the status of being a Certified Compressed Air System Specialist demonstrates that you have the knowledge and expertise in compressed air systems that sets you apart and gives confidence to the customers you serve.



Take the exam and get certified. Learn more and find how to get certified at the Compressed Air & Gas Institute's (CAGI) website:

**[www.cagi.org/personnel-certification](http://www.cagi.org/personnel-certification)**



# The AICD Conference is Back!

By Roderick Smith, Compressed Air Best Practices® Magazine

*Did you know 100 psi (7 bar) and 500 psi (34 bar) compressed air systems provide the pressure to shoot water into the air – making the famous Las Vegas Bellagio fountain show possible?!*

▶ The 2021 AICD Annual Conference and Exhibition was held May 16-18 at the Westgate Resort in Las Vegas. The official theme was “Playing to Win” but the unofficial theme, repeated by AICD (Association of Independent

Compressor Distributor) members and exhibitors alike was, “We’re Back!”

When the AICD Board courageously decided to move ahead with the event, they didn’t know

Nevada would drop its mask mandate, for vaccinated people, on May 13, 2021 and that Las Vegas casinos would follow suit the very day the AICD opened!



2021 AICD Board Members were “Glad to be Back!” Michael McCulley, Phil Kruger, AICD President Sal Calvo, Kasey Gould, Jeff Brennan, Dave Nosal, Bart Frush, and Brent Pifer (left to right).

In Memoriam. Thomas Robert Brennan (1949 – 2020)

AICD President Sal Calvo said, “We did it! We are fortunate and grateful to our membership for showing up in force at the same attendance levels we saw pre-COVID in 2019. Exhibitor attendance has also been strong and we are so thankful for everybody’s commitment to make this years’ event a success under these unusual circumstances.”

One change, unfortunately, became apparent when I ran into Jeff Brennan. His father, Tom Brennan, passed away in March, 2020. An AICD member for 32 years, you couldn’t find a stronger supporter. Over my career, I always looked forward to seeing Tom and receiving a dose of his positive Arizona energy. I’m sure he’s very proud to see Jeff continue his work at the AICD and provide leadership to Compressed Air Power, Inc. in Phoenix.

**The Conference**

The AICD has always had a strong conference format aimed at helping senior management, at air compressor sales and service companies, better manage their business. Speakers normally include economists with market forecasts, leadership and sales management gurus, and compressed air industry professionals with very tailored information for our market. This year was no exception and the 2021 line-up is below.

- J.R. Gillette, “The Economy and Your Business”
- Jay Johnson, “Employee Management and Sales”
- Hannah Kruger, “Social Media Marketing”
- Celebrity Speaker – Joe Theismann



Derrick Taylor and Joe Burke at the Unipipe/PneuTech booth (left to right).



Austin Wilkins, Bruce McFee, Horace Douglas, Larry Colley and Jackie Pifer (Central Air Compressor) at the Sullivan-Palatek booth (left to right).



Sergio “Red” Lopez, Stephanie Brockman and Robert Groendyke at the Hertz Kompressoren booth (left to right).

## The AICD Conference is Back!



Chris Canape, Ben Lucchese and Dominic Lucchese (La Frenz Mechanical), and Kevin Melisz at the Applied System Technologies booth (left to right).



Bart Frush (Modern Compressed Air), Molly Powers, Michael McCulley (Quality Compressed Air Services) and Bill Peters at the Clean Resources booth.



Dave Brockett, Dan Parker and Donnie Hendrickson at the ISEL booth.

I took something away from each presentation to help me manage my small business.

You can also count on the AICD to provide structured social events including receptions, lunches and dinners. This year's outdoor event included a fun afternoon where teams squared off at the Las Vegas Top Golf facility. For participants like me, it's fun to get points when the ball lands near a different hole than I aimed at!

### The Exposition – Platinum Sponsors

PneuTech introduced the Unipe aluminum piping system for compressed air, vacuum and nitrogen/inert gases. The system has pipe sizes with diameters from ¾" to 10". The UnipeAir system is rated for up to 232 psi (15.8 bar) and the UnipeHP system is rated to 1015 psi (69 bar). Joe Burke and Kevin Taylor showed us the systems' unique grip ring with a tapered fit, on their all-aluminum fittings, which if the pipe tries to pull away – it actually grips even tighter. These fittings are so secure they allow for the pressure ratings to 232 and 1015 psi and for a 20 year warranty on the pipe and fittings. During the show, they held a few fun hydraulic fluid “burst-pressure tests” – the average UnipeAir system burst pressure was 4,610 psi (313 bar) and the UnipeHP's was 7,429 psi (505 bar)!

At the Sullivan-Palatek booth, CEO Bruce McFee told me business has rebounded with strength but his comment for the record was, “How good it is for us all to be back together again”! Organizationally they have combined their industrial and portable compressor business under the sales leadership of Larry Colley. They are also making an effort to increase the brand awareness of their sister company, reciprocating air compressor manufacturer Saylor-Beall.



Hertz Kompressoren continues to build their U.S. presence and Stephanie Brockman has been promoted to Chief Operating Officer. They presented their new oil-free scroll air compressor product line going up to 40 horsepower. The HS-30 quadplex package was on display in a sound attenuating enclosure and is run by a PLC. They also offer duplex, triplex, and tank-mounted with dryer packages. Hertz VP and General Manager Bob Groendyke, by the way, gave me a cool run-down of all the medium and high-pressure compressed air systems powering the Las Vegas fountain shows!



Mike Kinnucane, Nitin Shanbhag and Jeff Crutchfield at the Mikropor booth sporting green shirts for their nitrogen generators (left to right)!

At the AICD booth for Applied System Technologies, Chris Canape told me their focus has always been on consistent product quality, same-day shipment inventory availability and superior customer service. In 2019, they moved into a larger Charlotte warehouse with 1 million linear square feet of aluminum piping in stock – with all the fittings required. He told me their significant investments ensure product availability and that you can speak to a live person when you need help.



Adrian Fernandez, Josh Borrego, Rusty Welch, Kent Tolman (Maddox Air Compressor) and Jason Hobbs at the BEKO Technologies booth (left to right).

Condensate management specialist, Clean Resources, was talking about their Super-Pak Series of oil-water separators designed for large compressed air systems with 4,000 to 10,000 cfm of air flow. The system ships pre-plumbed and functions on all types of air compressor lubricants.

ISEL told me to expect a third quarter 2021 launch of a new high temperature air compressor lubricant rated for 238°F (114°C) at 8000 continuous working hours. They also continue to promote their Universal 10,000 hour air compressor lubricant. A unique and largely ester-based formulation, they explained



Doug Flesner (Grimms Pump & Supply), Travis Moss, Todd Mueller (Grimms) and Marc Schlaiss at the Midwest Control booth (left to right).

## The AICD Conference is Back!



Kurt Erickson, Matt Piedmonte, Rick Walsh (Q Air-California), and Scott Werner at the Aerzen Rental booth (left to right).

it's top-off compatible with any air compressor lubricant and their top seller.

### Exhibitor Round-up

I will try here to provide insights into what was being talked about at a random sampling of booths at the AICD. Due to article space limitations, my apologies go out to all the booths/exhibitors not mentioned or photographed here.

The BEKO Technologies booth featured innovations to their Drypoint X heatless desiccant dryer. Manufactured in Atlanta, this product line has seen significant growth in recent years. New frame engineering has reduced the package weight and they now offer a series of important standard options for the product line including: low ambient temperature protection, all-pneumatic control, -100°F (-73°C) dew point, and an outdoor ambient protection package against wind, sun and rain.

Mikropor USA's President, Nitin Shanbhag, told me supply chains for the bulk liquid nitrogen industry are in trouble, with lead times greatly extended. He explained this has helped fuel strong growth for their nitrogen generation product lines. They offer a complete compressed air dryer, filter package and nitrogen generator solution. By the way, ask them about my favorite product of theirs, their CAGI-tested "less than 3 psi pressure drop" refrigerated dryer package with integrated prefilter and afterfilter!

At the Midwest Control booth, Marc Schlaiss explained their MCDV timer drain has been selling well due to a full 2-year warranty on their ¼", 3/8" and ½" sizes which ship same-day with a standard strainer valve. What caught my eye was their line of timer



Frank Moskowitz and Steve Briscoe at the Compressed Air Challenge booth (left to right).



Jim and Rowena Griffin (Starr & Company), Ryan Fultz and Zane Baker at the SMC booth (left to right).

drains with a digital display. He also said their line of Condor pressure switches (for air compressors) is very popular.

Matt Piedmonte is leading the Aerzen Rental team, whose facilities are based in Atlanta. The concept of applying low pressure (<50 psi (<3.4 bar) tri-lobe, screw or turbo blowers to rental applications requiring these pressures – rather than using the traditional diesel or electric 100 psi (7 bar) air compressors – is really taking hold. They attended the AICD to increase the awareness amongst air compressor distributors of this energy-saving option for clients.

The Compressed Air Challenge had a booth manned by Frank Moskowitz and CAC President Steve Briscoe. They reported their online training classes are being received enthusiastically.

SMC is a global leader in pneumatics. What a lot of “compressed air people” don’t know is they have a proven range of refrigerated compressed air dryers, membrane dryers and filters. Their filter line includes bulk water separators, particulate filters and oil coalescing filters. SMC has a huge product offering including chillers (some specifically designed for laser cutting), bag house pulse filters with extended cycle capabilities, a suite of energy-saving pneumatics and on-machine flow meters/pressure regulators for those interested in demand-side auditing/measurement tools. The potential for deployment of these products by demand-side auditors is enormous – and with SMC’s support one can optimize production equipment safely!

BOGE America in recent years, under the leadership of Gavin Monn and Jerry Elsen, has made significant steps forward. They

gave me an update on their ever expanding product offering including the SRHV Booster which now offers pressures up to 580 psi (40

bar). Their tank-mounted C-2 Series rotary screw (15 to 30 hp) comes with an integrated refrigerated dryer and has direct or belt-drive



Gavin Monn, Pam Tetterton and Jerry Elsen at the BOGE booth (left to right).

## Host a CAC L1 Training ONLINE TODAY

**Interested in hosting the Fundamentals of Compressed Air Systems (L1) training online? CAC instructors are now able to provide the L1 training online! Contact us today to get your training scheduled! CAC will work with hosts to identify dates, times and available instructors.**

Like the popular in-person class, the web-based workshop is designed to teach facility engineers, operators, and maintenance staff how they can achieve 15-25 percent cost savings through proper operation and controls, system maintenance, and appropriate uses of compressed air. Both the in-person and web-based classes utilize the same basic content and adhere to the CAC’s principles of product-neutrality and a focus on the systems approach to managing compressed air.

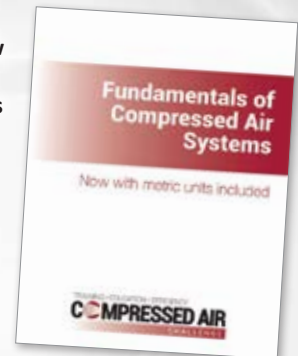

**For more information, please contact CAC Executive Director, Tracey Kohler at [tkohler@compressedairchallenge.org](mailto:tkohler@compressedairchallenge.org).**



- /CACknowPressure
- /company/compressed-air-challenge
- /CACknowPressure

## The AICD Conference is Back!



Frank O'Connor, Kevin Stern and Chuck Henderson at the Henderson Engineering booth (left to right).

options. Lastly, a big step has been the success of the S-4 Series rotary screw starting at 100 horsepower.

Henderson Engineering continues to provide a full suite of engineered compressed air dryers under the brand name of Sahara Air Dryers. A leader in the manufacturing of heat of compression dryers, they also offer heatless, exhaust purge and blower purge desiccant dryers. As oil-free air compressors gain market share, the arguments in favor of heat of compression dryers become even more significant. Kevin Stern leads their sales efforts and is a very valuable resource when it comes to applications.



Natalie Fontana, Tony Montalto and Matt Smith at the FS-Curtis and FS-Elliott booth (left to right).

FS-Curtis and FS-Elliott now offer distributors an amazing range of reciprocating, rotary screw and centrifugal air compressors. Matt Smith told me their big news is the launch this summer of their new ECOTURBO oil-free, air-cooled or water-cooled, 2-stage centrifugal air compressors with models starting with 250 horsepower (185 kW) and 350 horsepower (250 kW) units. The line will eventually be extended down to 175 hp (132 kW). He said these units are designed to compete effectively with oil-free rotary screw air compressors.



Bob McKay, Chris Foster, Joe Rodenbucher, Charles Algiene and Jim DiMaiolo at the Altec AIR booth (left to right).

Altec AIR continues their “Made in Colorado” theme for their full range of refrigerated and desiccant dryers. They told me their UA Series of non-cycling refrigerated dryer has models from 20 to 3,000 cfm, uses R-134a refrigerant and is in stock up to 2000 cfm for next-day shipment in their New Jersey and Denver warehouses. They were also launching their new A Series modular filter line using extruded aluminum housings.

Hydrothrift continues to provide the industry with custom-engineered cooling systems,

leveraging their unique expertise with the compressed air application. Mike Wlodarski said they are having great success with their PCX water to water isolation heat exchangers used in closed loop cooling systems. Air compressors experiencing issues with cooling tower supplied water are great candidates for this system.

Sauer Compressors USA is based in Stevensville, Maryland and is an important supplier to the U.S. Navy. They told me they offer dockside air for many naval bases, including breathing air solutions. At the show they were talking about their medium and high-pressure rental program offering solutions up to 5000 psi! They also have high-pressure dryer rentals which can offer Grade D and E breathing air. This is heavy-duty equipment – check out their cool YouTube pages if you get a chance!

Solberg Filtration was present with Charlie Solberg echoing the theme at the show, “We are happy to see everybody and to see the industry again getting on a roll!” NANO was also there celebrating their 10-year anniversary with some choice cupcakes – congratulations! They are currently promoting their D Series of desiccant dryers manufactured in Pennsylvania.

OZEN Compressors had a booth where they talked about their new three-stage reciprocating boosters with pressures of 3600 psi (245 bar) and 5000 psi (340 bar) – which they say are particularly suited for laser-cutting applications.

Kingston Valves has been manufacturing valves since 1908 (amazing!) in sunny Southern California. Maddie Lester and Theresa Hinkler told me their best-sellers are their angle-seated valves for desiccant dryers, the KNG



Jim Riley, David Jens, John Temple and Scott Miller (Air-Vac Systems) at the Sauer Compressors USA booth (left to right).



Clint Browning, Charlie Solberg and Andy Spicer at the Solberg Filtration booth (left to right).



Celebrating their 10-year anniversary are Mike Ellis, Todd Allison, Nick Herrig, Jane Sexton and Tony Hergert at the NANO booth (left to right).

## The AICD Conference is Back!



Keith Beatty and Mike Wlodarski and the Hydrothrift booth (left to right).



Brandon Dial and Dave George at the Kaishan booth (left to right).



Hannah Kruger, Phil Kruger (Harris Equipment), Keith Sportsman and Brent Pifer (Central Air Compressor) at the ELGi booth (left to right).

line of ½" to 3" safety valves, and their KSV line of 1/8" to 1 ¼" soft-seal safety valves.

Control Devices is another interesting valve firm and Michael Lewis said their new weighted Flexi-Hinge blower and vacuum relief valves (up to 3") are doing extremely well due to their one week lead times.

At the Kaishan booth, Dave George told me they have started manufacturing airends already out of their Loxley, Alabama production center. They were talking about the launch of their new 30 to 100 horsepower, 2-stage, VSD rotary screw air compressor line.

ELGi moved into a new, larger facility in Charlotte in October, 2020. Keith Sportsman said they are currently launching the new AB Series of water-injected single-stage rotary screw air compressors with models from 20 to 150 horsepower. This product line will complement their OF Series of oil-free rotary screw air compressors with models from 50 to 500 horsepower. He also mentioned their belt-drive EN Series now has a VFD option.

### Conclusion

Once again, the AICD exceeded expectations – and it's indeed BACK and better than ever! I hope this report provides a taste of what happened – there's no way to cover the whole event and do all the exhibitors justice in these short pages. **BP**

For more information, please contact Kasey Gould, AICD Administrator, tel: 409-860-9961, email: [admin@aicd.org](mailto:admin@aicd.org), or visit [www.aicd.org](http://www.aicd.org)

To read more about **Compressed Air Technology**, please visit [www.airbestpractices.com/technology](http://www.airbestpractices.com/technology)

# CHILLER & COOLING BEST PRACTICES

[coolingbestpractices.com](http://coolingbestpractices.com)

July 2021

## Hospitals

### COOLING TOWERS & CHILLERS

- 42 Vapor Compression Applied in Heat Pumps
- 48 Free-Cooling Chiller Systems

### WATER TREATMENT & COOLING SYSTEM ASSESSMENTS

- 52 Boston Hospital Cuts Energy Bills 33% with Chiller Optimization
- 56 Ice Storage or Chilled Water Storage? Which Is Right for the Job?

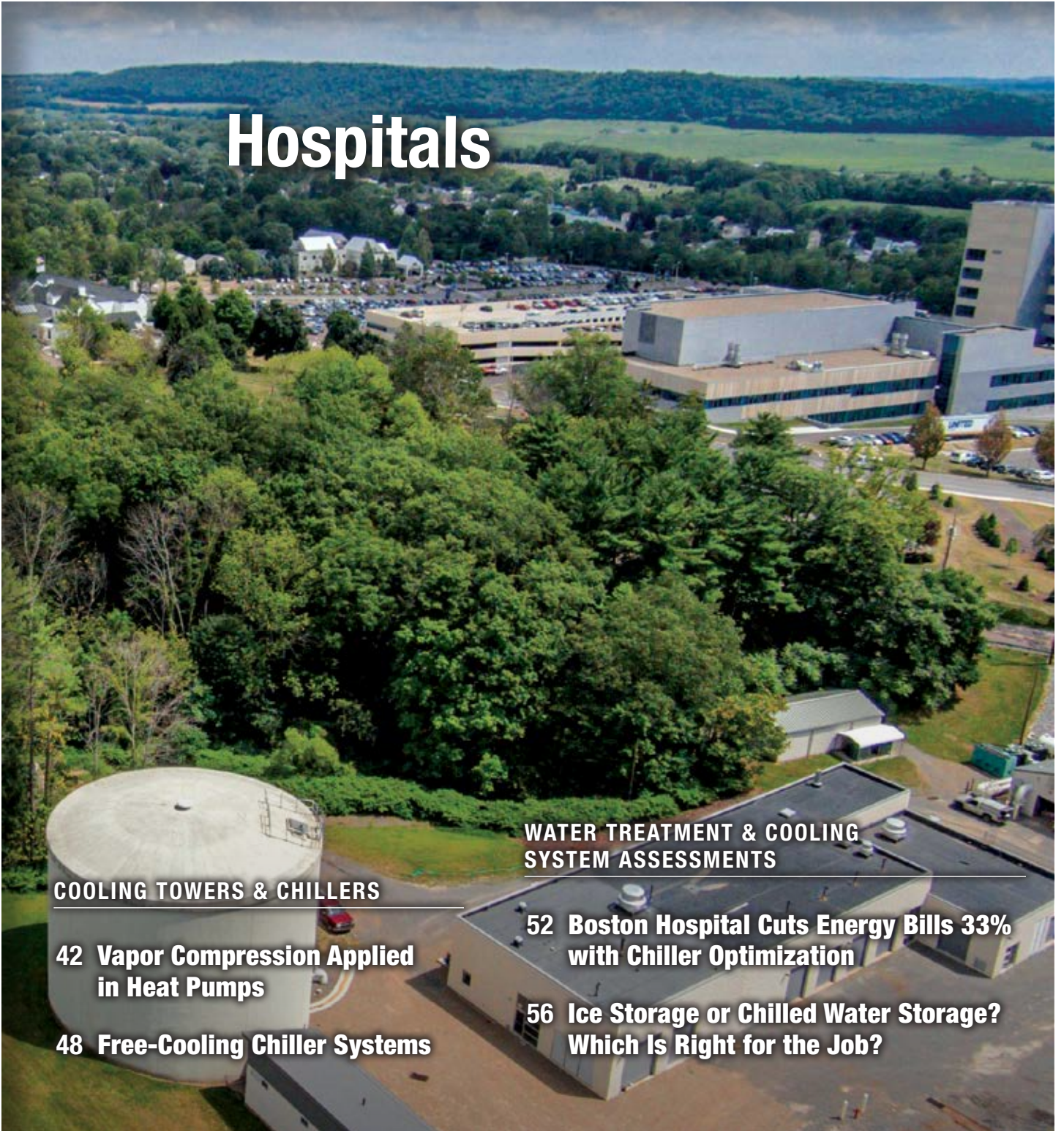

# BEST PRACTICES

2021 EXPO NOVEMBER 2-4 CHICAGO, IL  
COMPRESSED AIR / VACUUM / COOLING



## OPTIMIZE ON-SITE UTILITIES

Powering Automation

Research and Identify Innovations  
to Enhance the Efficiency and Reliability of Your Systems

### Compressed Air

Air Compressors  
Air Compressor Controls  
Air Purification & Piping  
Condensate Management  
Pneumatics

### Blower & Vacuum

Aeration Blowers  
Industrial Blowers  
Vacuum Pump Systems  
Inlet Filtration/Oil Separators

### HVAC & Process Cooling/Steam

Chillers  
Heat Exchangers  
Cooling Systems  
Cooling Towers  
Water Treatment  
Boilers  
Steam Traps

Motors & Drives • Lubricants • Measurement Instruments • IoT Automation & Monitoring

### EXPO HOURS

Tuesday, November 2 12:00-6:00PM

Wednesday, November 3 12:00-6:00PM

**SAVE THE DATES ON YOUR CALENDAR!**  
Located at the modern Schaumburg Convention Center  
just 10 minutes from Chicago O'Hare International Airport.

[cabpexpo.com](http://cabpexpo.com)

Sponsored by







56

**COOLING TOWER & CHILLER FEATURES**

**42 Vapor Compression Applied in Heat Pumps to Reduce CO<sub>2</sub> Emissions**

By Drew Turner, Danfoss

**48 Free-Cooling Chiller Systems**

By Tom Stone, Thermal Care

**WATER TREATMENT & COOLING SYSTEM  
ASSESSMENT FEATURES**

**52 Boston Hospital Cuts Energy Bills 33%  
with Chiller Optimization Solutions**

By Eddie Rogers, tekWorx

**56 Ice Storage or Chilled Water Storage?  
Which Is Right for the Job?**

By Paul Valenta, Trane



48

**TECHNOLOGY NEWS**

**63 Chiller & Cooling  
Systems**

**EVERY ISSUE**

**4 From the Editor  
65 Advertiser Index**



52

*COVER PHOTO. This month's cover features a 1 million gallon chilled water storage tank used in a cool storage system at a medical center, the subject of the article titled, "Ice Storage or Chilled Water Storage?", provided to us by Trane.*

# Vapor Compression Technology Applied in Heat Pumps to Reduce CO<sub>2</sub> Emissions

By Drew Turner, Global Marketing Manager, Danfoss

► The inefficiency of fossil fuels, along with the negative environmental impact coming from their burning and resulting emissions, is driving companies to find alternative heating and cooling solutions. While renewable sources – such as wind and solar power – are decreasing this impact, other fossil fuel-burning sources need to be replaced with electric-driven alternatives to fully realize their emissions reduction potential. New vapor compression technology can help reduce heating and cooling operations while providing these additional CO<sub>2</sub> emissions reductions.

Air-to-water heat pumps provide much more efficient heating compared to fossil fuel-sourced solutions. They are approximately 3.5 times more efficient than boilers, before accounting for the transmission and distribution losses. Even with the inefficiencies of the power generation needed to fuel electric heat pumps, there is still an

opportunity for this air-to-water heat pump to realize about 35% operating cost reduction, as well as 60% emissions reduction.

Recent heat pump vapor compression innovations are much more efficient – particularly at part-load operation – whereas boilers and furnaces do not see significant additional efficiencies at part-load conditions.

The goal of eliminating CO<sub>2</sub> emissions requires a reduction in energy consumption and the decarbonization of the energy consumed, while finding alternatives to inefficient fossil fuel-fired heating sources. By nature, heat pumps – and especially these more recent innovations – are intended to optimize energy for both cooling and heating at those varying operating conditions.

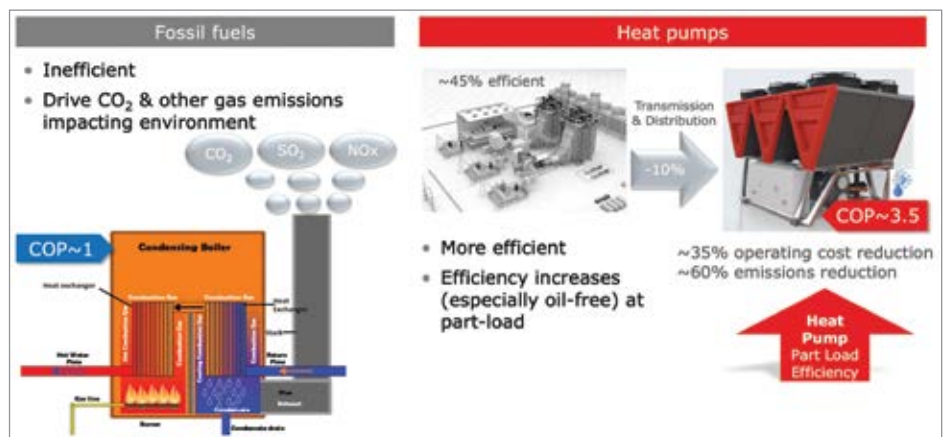

**U.S. Clean Energy Commitments**

As U.S. federal climate policies and strategies continue to evolve, efforts from individual states are already underway to implement a significant increase of renewable energy sources. According to the World Resources Institute, in 2019, multiple states committed to a 100% renewable energy source. Deadlines for reaching these goals ranged from 2035 to 2050.

However, the reality must match the commitment. To this end, 76% of all 2020 new US planned power generation capacity is either wind or solar. Additionally, the IEA in November 2020 provided an update

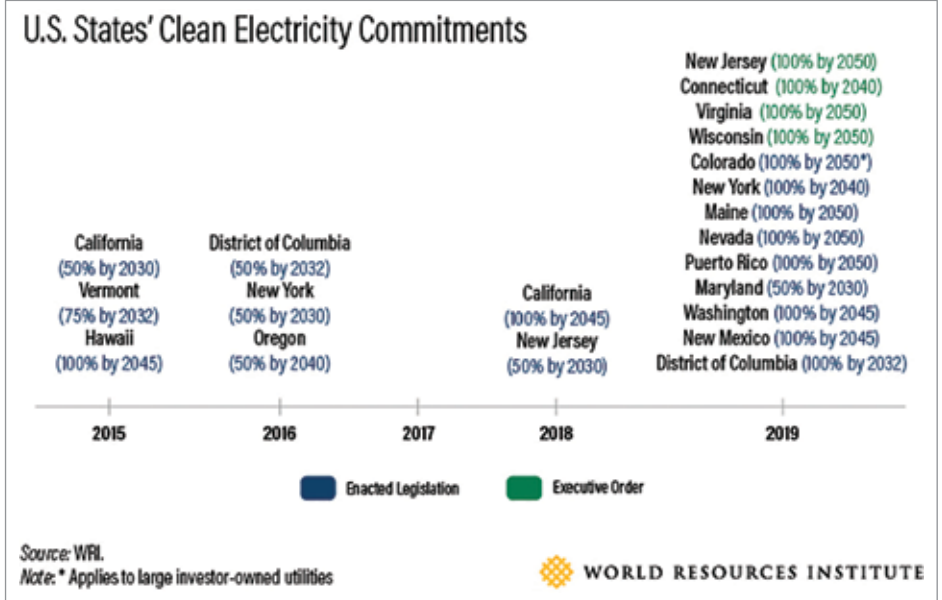

**No Performance Degradation for the life of the compressor**



**Expanding oil-free technology to higher capacities**

**Danfoss Turbocor® VTX1600 Compressor**

Introducing the VTX1600 compressor, the largest capacity oil free centrifugal compressor offered by Danfoss Turbocor®. The 450 ton / 1600 kW nominal capacity rating brings the benefits of oil free technology to chillers up to 3600 tons / 12,660 kW or larger.

Oil free technology provides a wide range of benefits through high efficiency, low maintenance, quiet operation, small physical footprint and no performance degradation.

For more information, visit [turbocor.danfoss.com](http://turbocor.danfoss.com)



ENGINEERING TOMORROW



## Vapor Compression Technology Applied in Heat Pumps to Reduce CO<sub>2</sub> Emissions

that, globally, renewables constituted 90% of this year's new installed power generation. As the nation transitions to renewables, there will always be a need for some level of backup, since these natural resources are at the mercy of the environment. These backups – historically known as peaking plants – are necessary when the demand side is high and there are renewable source deficiencies. These constitute the remaining 24% of new 2020 planned generation capacity. Significant growth in the percentage of renewables in the electric power generation portfolio is driving the need for heat pumps that are replacing fossil fuel-based sources and driving an additional increase in the decarbonization potential.

### Utilities Are Changing to Support Renewables

In response to the shift to renewable energy sources, utility programs are being pushed to balance demand based on those same supply variations. Again, since renewable power sources may not be available during peak load times, utilities must turn to clean, alternative sources that can balance demand.

Heat pumps are critical to programs that can react when renewable generation sources are not available. As renewable energy volume grows, utilities are motivated to implement heat pumps that can adjust to those supply variations. Since the wind and sun do not always cooperate – leading to a disconnect

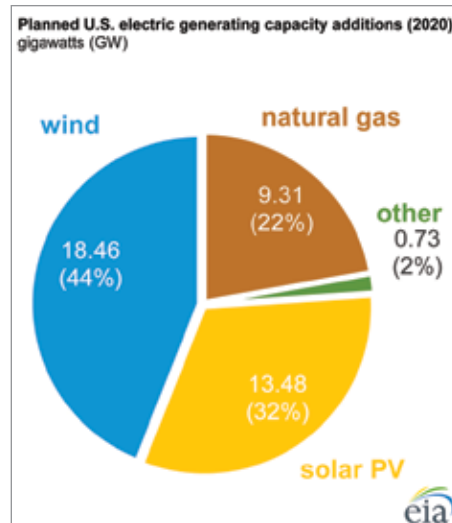

between supply and demand – addressing that disconnect requires energy storage and heat pump technologies that can modulate energy usage to available supply.

Energy storage takes many forms. There is battery storage, pumped hydro storage and thermal storage, among others. For HVAC, thermal storage is today anywhere from 1-10% of the applied cost of battery storage, which translates to significant savings over an extended period. Therefore, thermal storage becomes integral to addressing the disconnect between integrating more renewables to supply the demand side.

Grid-interactive efficient buildings require efficiency, load, shift, shed and modulation to quickly act on the demand side to deficiencies on the supply side. These building are also

shifting to the concept of separate, sensible and latent load cooling – which can increase efficiency and reduce resulting energy use.

### District Energy Systems

First developed in the US in the Edison days, district energy systems are a highly efficient way to heat and cool a group of buildings from a central plant. In Europe, district energy systems have evolved over time to operate at lower temperatures, which – in turn – allows other heat recovery and heat pump sources. Grid-interactive heat pumps and thermal storage provide an optimal flexibility district energy system. While district energy systems offer flexibility to meet efficiency goals, they are challenging to implement where no required infrastructure currently exists. However, the long-term value of district energy systems lies in the ability to create a symbiosis that enables heat recovery from vapor compression cooling of multiple heat pump sources, replacing former chillers in cooling-only applications.

### Compression Technology Supports the Trends

There are two main compression technologies for HVAC systems: dynamic compression and positive displacement compression. Dynamic compression adds kinetic energy to the refrigerant, while positive displacement harnesses potential energy by “squeezing” it and reducing the area.

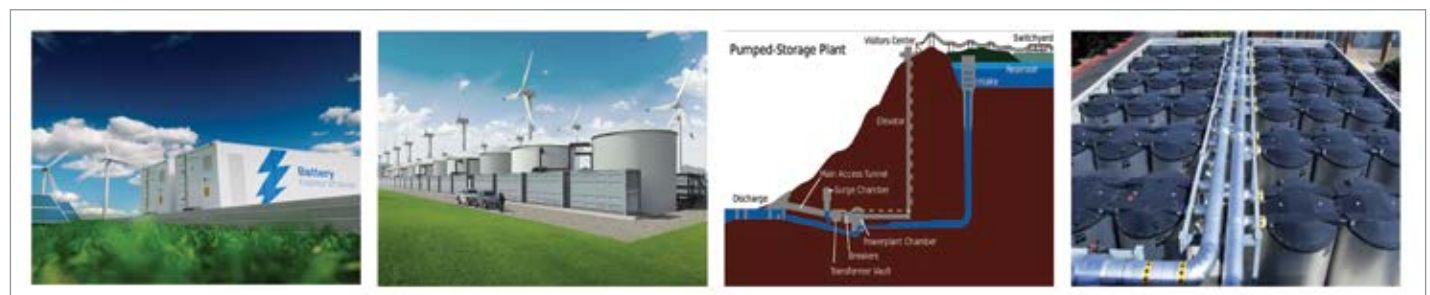

There are also a variety of bearing types. Historically, oil-based bearings are found in most traditional compression technologies. Today, there are several oil-free options, including magnetic, ceramic and gas bearings. Among newer compression technologies, magnetic bearings provide flexibility in terms of capacity, reliability and efficiency.

Because oil-free compressors minimize physical size through high-/variable-speed operation, they are ideal for retrofit applications where a smaller footprint may be required. Additionally,

since these same compressors have no mechanical contact, oil-free machines are quieter and easier to maintain.

**Next Phase of Refrigerants**

These evolving dynamic, variable speed, oil-free vapor compression technologies utilizing new HFO refrigerants can potentially further reduce refrigerant CO<sub>2</sub> emissions, as reduced pressure and density can lead to lower global warming potential (GWP) with minimized flammability. The coming years will likely bring lower-pressure and lower-density

refrigerants, and supporting technologies optimized for their use.

It is critical to optimize these dynamic centrifugal compressors to their target application operating temperatures. There are three basic optimizations on the market today:

- Standard lift optimization for lower lift or lower differential operating temperatures, which support water-cooled, evaporative-cooled and hybrid chillers

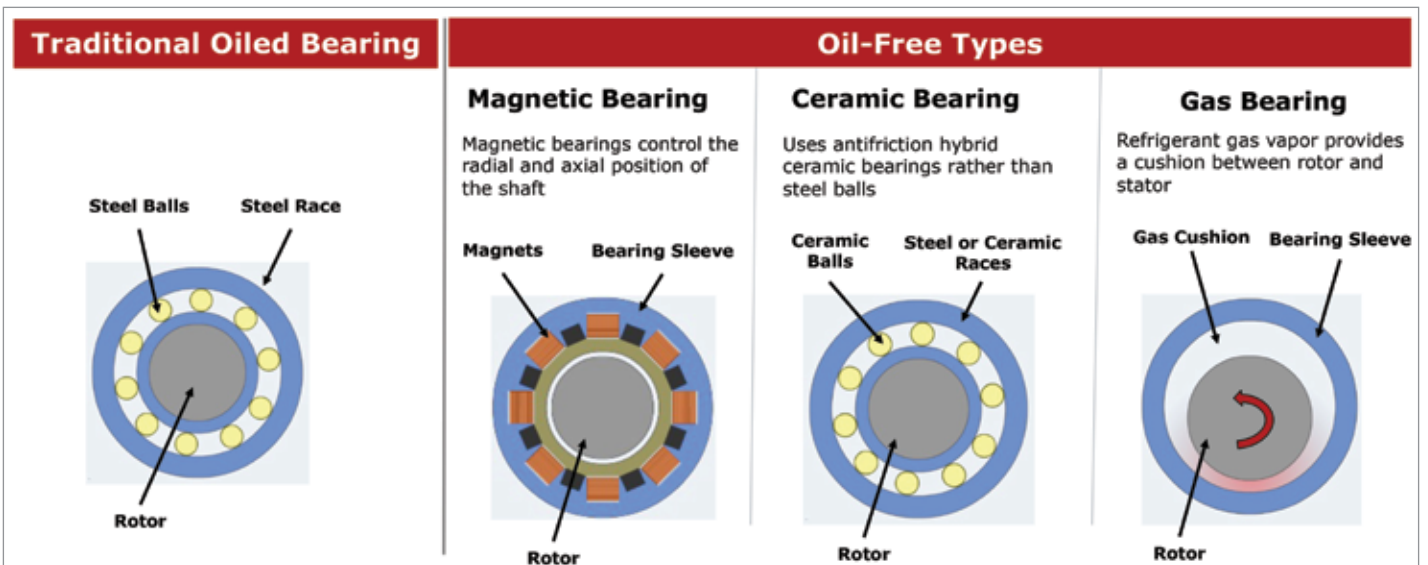
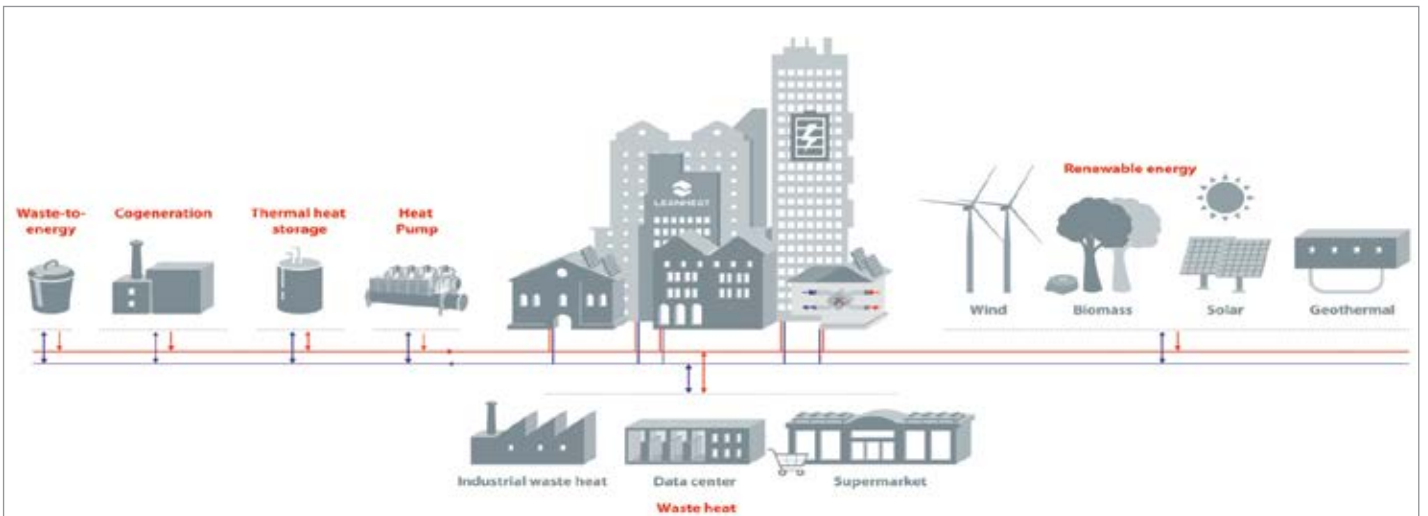

## Vapor Compression Technology Applied in Heat Pumps to Reduce CO<sub>2</sub> Emissions

- Medium lift optimization for air-cooled chillers, water-cooled chillers in more challenging environments and water-to-water heat pumps with lower required heating temperatures and/or higher cooling/heat-source temperatures
- High lift optimization – the most recent innovation for oil-free compressors – is on the mechanical design of the compressor, along with the aerodynamic compression process. It supports the most challenging applications, including very high ambient air-cooled chillers, water-to-water heat pumps with higher heating

and/or lower cooling/heat source temperatures, air-to-water heat pumps in milder climates, medium-temp process cooling and thermal storage applications.

All vapor compressors have two sets of forces in the compression process: the radial (side-to-side) motion of the shaft driving the compression process and the axial (back-and-forth) motion. While older compressor designs had both stages of compression on one end of the compressor, new high-lift optimization technology moves the second stage of compression to the opposite end, which balances those axial forces. The two

compression stages pulling back against each other enables a higher differential temperature capability, despite the fact there is still no mechanical contact.

### New Technology Supports Multiple Applications

The most recent version of this vapor compression technology can now provide those same technology benefits formerly relegated mainly to comfort cooling chillers applied in milder climates, now to the hottest environments, provide cooling at lower temperatures – including thermal storage – or provide heating with heat pumps. What were once unattainable applications for magnetic-bearing-based compressors is no longer the case, thanks to this evolving technology that enables operation in more challenging applications.

The success of European district energy systems demonstrates the best way to optimize energy efficiencies is through a combination of technologies and heat sources. There may not be one compressor type that fits into the optimal system. Depending on operating temperatures, heating, return and water temperature may require a combination

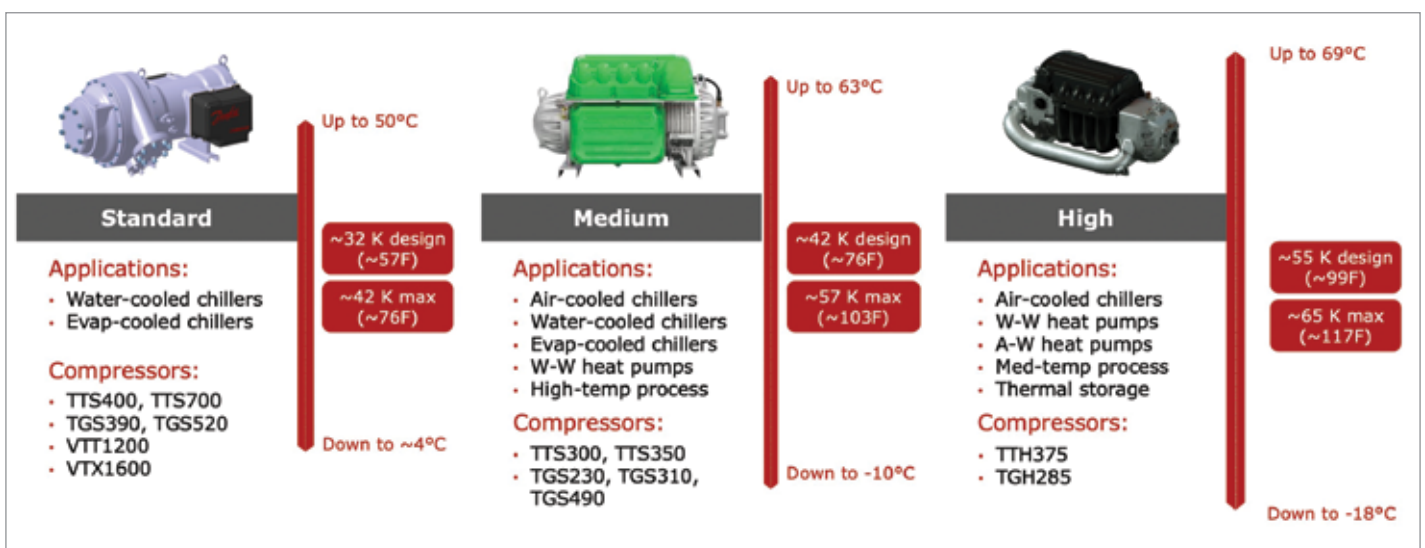
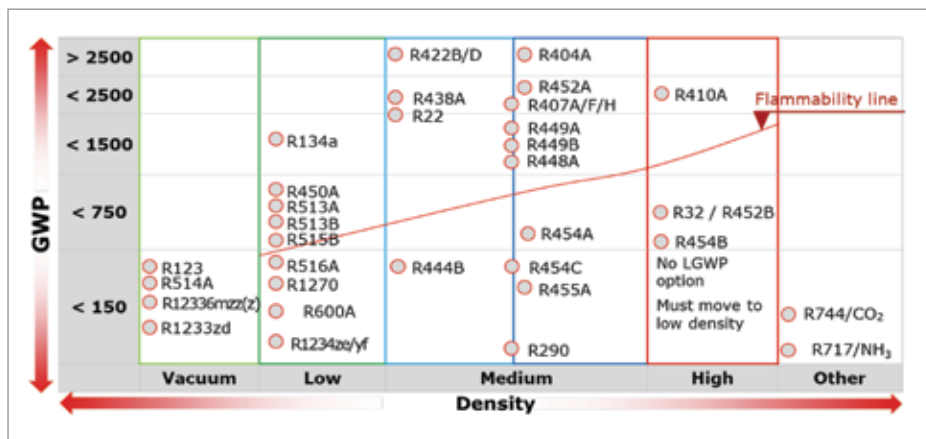

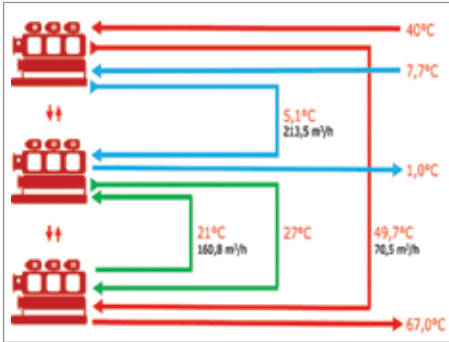

of a medium lift and high lift compression design in a series counter flow arrangement to, in-turn, enable the most efficient solution that meets the application requirements.

Oil-free design allows engineers to combine a variety of technology to optimize based on real-world conditions. For example, where cooling is required for industrial manufacturing, this technology can provide cooling and then recover the heat through a symbiosis heat pump, which boosts the temperature to supply the district heating system. When the industrial process is not operating, a parallel geothermal ground-source loop can also supply heat to the district heating system via that same heat pump. This dual cycle system can enable full-time supply as the baseload of a district heating system, maximizing operating hours and helping buildings recoup the first cost investment in less than three years.

**Finding the Right Solution**

An evolving portfolio of magnetic bearing, variable speed dynamic vapor compression technology can support an expanding array of applications with a variety of compressor combinations to maximize operational efficiency while lowering CO<sub>2</sub> emissions.

It is important to understand the needs of the specific application to design the optimal system solution that maximizes energy efficiency and minimizes CO<sub>2</sub> emissions, while at the same time lowering operating costs. Manufacturers like Danfoss offer components, including compressors and other oil-free system components, that are designed, optimized and rigorously tested to meet the demands for a wide range of applications, now including heat pumps and others even more challenging – the portfolio is expanding with industry trends in-turn driven by the need to reduce CO<sub>2</sub> emissions. **BP**

**About the Author**

*Drew Turner, global marketing manager for Danfoss, has 23 years' experience in the HVAC industry. He holds a bachelor's degree in industrial engineering from Oklahoma State University and a master's degree in business administration from the University of Colorado.*

**About Danfoss**

*Danfoss engineers advanced technologies that enable us to build a better, smarter and more efficient tomorrow. In the world's growing cities, we ensure the supply of fresh food and optimal comfort in our homes and offices, while meeting the need for energy-efficient infrastructure, connected systems and integrated renewable energy. Our solutions are used in areas such as refrigeration, air conditioning, heating, motor control and mobile machinery. Our innovative engineering dates back to 1933 and today Danfoss holds market-leading positions, employing 27,000 and serving customers in more than 100 countries. We are privately held by the founding family. Read more about us at [www.danfoss.com](http://www.danfoss.com).*

To read more articles about **Refrigeration Compressor Technology** visit <https://coolingbestpractices.com/technology/refrigeration-compressors>

**DeCaIon™**

**ULTIMATE SOLUTIONS FOR COOLING WATER MANAGEMENT**

*Changing the way we manage water. For good.*



Introducing patented DeCaIon™, a revolutionary chemical free descaling, biocides and corrosion inhibitor. No outage required for installation. Over 100 units in operation worldwide!

<b>ZERO</b> chemicals	<b>10-25%</b> less energy usage
<b>Over 50%</b> less water usage	<b>30-50%</b> less wastage



Visit our websites:  
[www.decaion.com](http://www.decaion.com)  
[www.grocllc.com](http://www.grocllc.com)  
[www.decaion.com.sg](http://www.decaion.com.sg)



# Free-Cooling Chiller Systems

By Tom Stone, Thermal Care

► Free cooling is a type of process cooling system design that takes advantage of ambient temperatures to reduce or even eliminate chiller operation. Chillers consume large amounts of energy; so, reducing a chiller's operating hours per year can result in significant bottom line savings for your company. In this article, we will review a typical free cooling system design, some of the considerations for your system, and finally, how these considerations impact your system's ability to capitalize on the free cooling operation.

The practice of free cooling uses low ambient temperatures to achieve a setpoint that would normally require a chiller with mechanical refrigeration. Access to these low ambient temperatures is considered "free" because it is simply based on your geographic location and climate. Using this environmental benefit to your advantage saves the cost of operating a chiller.

First, before we can dive right in with free cooling, we need to step back and review the typical components of a large process cooling system. These are the central chiller, fluid cooler, and pumping system. Understanding what each of these components do and how they interact with each other will be the basis for our free cooling design discussion.



Central chillers are typically used to support the total process cooling needs of a facility.



### What is a Central Chiller?

A central chiller is a large capacity cooling unit that typically supports an entire facility's processing needs or at least a large portion of it. These units are available in three main configurations: air-cooled, water-cooled, and remote air-cooled. An air-cooled chiller is a packaged unit where the refrigeration circuit, including the compressor, is housed within the same framework as the condenser and fans. It represents a self-contained, packaged solution. The fans are used to force air over the condenser and reject the heat removed by the chiller to the atmosphere. A water-cooled chiller uses a water-to-refrigerant heat exchanger as the condenser instead of an air-to-refrigerant heat exchanger. This requires a cooling tower system to provide the water to cool the condenser. A remote air-cooled chiller, also known as a split system, takes a packaged air-cooled chiller and separates the chiller's compressor and most of the other refrigeration components, from the condenser and fans. The piece of equipment with the condenser and fans is known as the remote condenser. The indoor chiller and outdoor remote condenser are then connected with refrigerant piping in the field.

The packaged air-cooled chiller is typically installed outdoors because it rejects the heat removed from the process into its surrounding area. A water-cooled unit is installed indoors, and the split system chiller is installed indoors with the remote condenser installed outdoors where it can expel the system's heat.

### What is a Fluid Cooler?

A fluid cooler is very similar to a radiator in your car. It uses forced air over a coil to remove heat from a fluid. These units are installed outdoors and use ambient air to provide cooling. As the air temperature rises, the ability for the unit to reject heat to the atmosphere is reduced. This means during warm months, the fluid cooler is unable to achieve lower fluid temperatures. Conversely, during cooler periods of the year, the fluid cooler can achieve lower temperatures similar to a chiller. This is a key distinction to understand because it is a primary concern when designing a free cooling system.

### What is a Pumping System?

The last major component of a process cooling system is the pump/tank skid. These units have a tank and pumps mounted to a common skid. The tank provides additional mass to the system which acts as a thermal flywheel. This buffers any process heat load spikes and helps maintain steady temperature control. The pumps are used to circulate the fluid through the system. This fluid, typically water or a water/glycol mixture,



*Fluid coolers are installed outdoors and use ambient air to provide cooling.*



*Pump tanks work in conjunction with a central chiller and fluid cooler to provide a central water distribution system.*

acts as the medium to transfer heat from the process back to the cooling system's equipment. The cooling equipment is used to extract the heat and reject it from the system.

The most common pumping configuration uses separate process pump(s) and recirculation pump(s) coupled with a dual well tank

## Free-Cooling Chiller Systems

(hot and cold wells). The process pump circulates fluid from the tank's cold well, pumps it to the process to remove heat, and then returns to the other side of the tank – the hot well. A recirculation pump pulls from the hot well and pumps the fluid to the system's cooling equipment, i.e. – a chiller or fluid cooler, where the heat is rejected from the system. The now cooled fluid returns to the tank's cold well to start the circulation loop over again.

Pump/tank skids like these use a partial divider to not only allow the two wells to equalize if the flow rates from each side are different, but also provides enough separation to help maintain the hot and cold sides. This contributes to better temperature stability. The other variation of this pumping design uses a full divider. This design completely isolates each side of the tank and requires an external heat exchanger to transfer the heat from the process loop to the recirculation loop. There is some efficiency loss through the heat exchanger but it allows the two fluid

loops to be completely separate. The key benefit of a fully divided tank, when considering free cooling designs, is that it allows the use of glycol. The glycol mixture loop is recirculated through the chiller and/or fluid cooler located outdoors, while the process loop can still use pure water to support the equipment in the facility that generates the heat.

### What is Free-Cooling?

Now that system components have been defined, understanding a free cooling system is much more straightforward. The most effective design for free cooling installs a fluid cooler in series before the chiller in the recirculation pump loop. This means that the fluid in the loop passes through the fluid cooler prior to reaching the chiller. Another common configuration has the fluid cooler installed in parallel to the chiller. In this design, the recirculation loop supplies either the chiller or fluid cooler. This is accomplished with a diverting valve or with a dedicated pump loop for each piece of equipment.

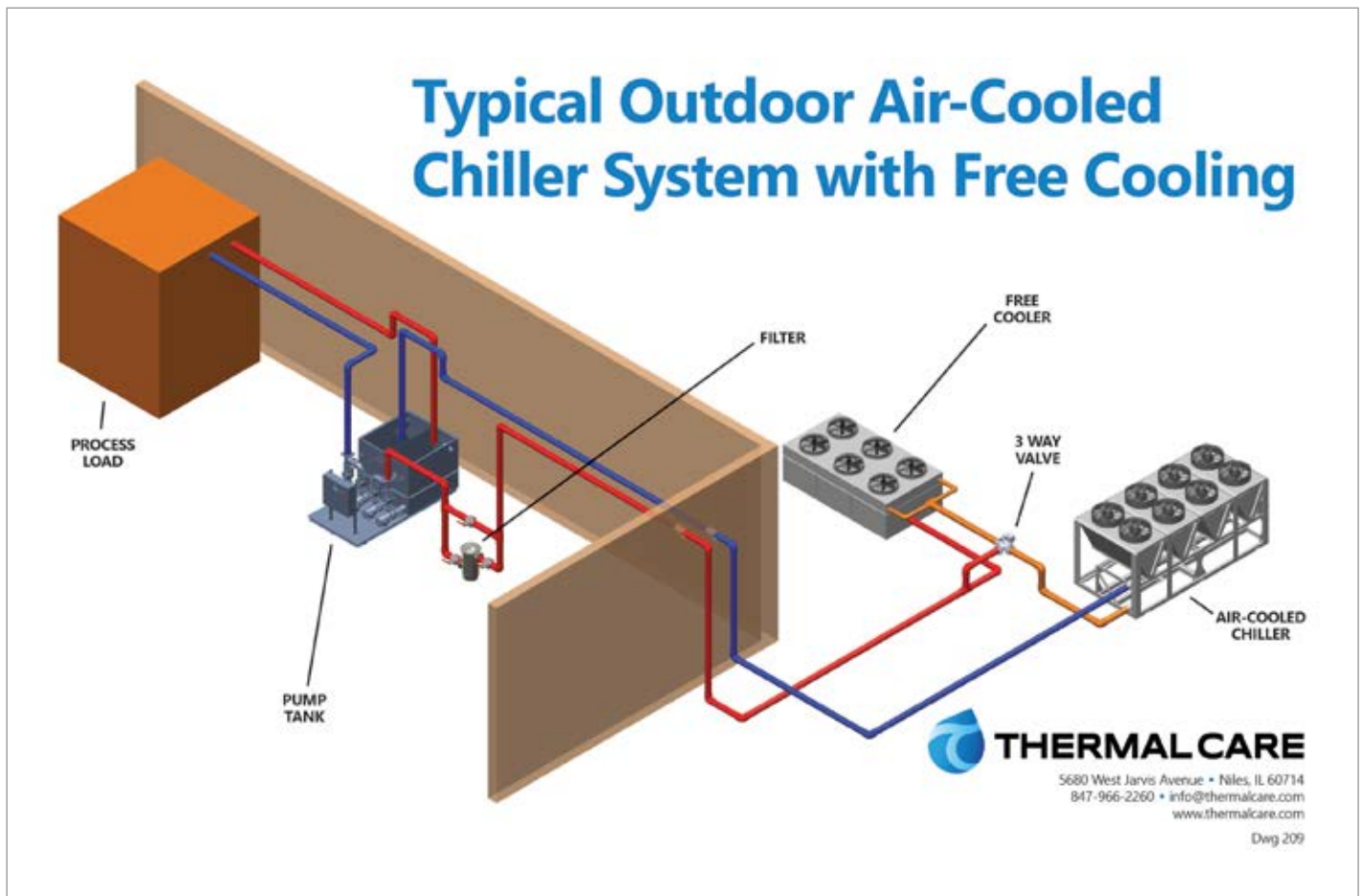

A free cooling system reduces energy use by using a fluid cooler or cooling tower to cool the process fluid in place of a chiller.

The parallel setup was most common when free cooling designs were first implemented for process cooling. The control setup was simple and easy to use. However, the energy saving benefits were reduced. There was no ability to use partial capacity to take advantage of a chiller's ability to unload, lowering its energy consumption.

Installing the fluid cooler in series is now widely accepted as the best solution for free cooling. The key advantage of a series design is known as load shedding. This is in addition to the 100% load coverage available with a parallel system design. In the series configuration, the hot fluid passes through the fluid cooler first before reaching the chiller. Even in instances when the fluid cooler cannot meet the full cooling requirement, such as when the ambient temperature is not low enough, it can still remove part of the heat load. The now partially cooled process fluid leaves the fluid cooler and enters the chiller at a lower temperature. This signals the chiller that only part of its available cooling capacity is required allowing the chiller to unload.

As unloading technology has improved, energy savings have followed. For example, VFD controlled centrifugal compressor chillers with magnetic bearings can decrease their speed much lower than a traditional style compressor. A magnetic bearing compressor has a much lower minimum pressure differential because there is no oil. As speed is reduced, the energy consumption is reduced by a cubed relationship. Even for the same amount of load shedding, the energy savings between a traditional style compressor and a magnetic bearing compressor is drastically improved.

There are also chiller designs that incorporate multiple refrigeration circuits that each use multiple compressors. This creates many discrete stages of unloading by turning compressors off. Each stage reduces the energy consumption. Coupling this design with advanced refrigeration controls such as floating head pressure controls can improve energy efficiency even more.

A few of the key items to consider when determining if a free cooling system is right for you:

- Does your cooling system's setpoint allow you to take advantage of ambient conditions?
  - By truly understanding your system's setpoint requirement, you may be able to gain large periods of time during the year

for free cooling. In some instances, simply adjusting your setpoint up by 5°F can add 500+ hours per year when your chiller can be completely shut off.

- Is the climate in your area conducive to a free cooling system?
  - Many Northern climates have enough time per year at lower temperatures that a free cooling system can replace a chiller for over 50% of the year.
  - Even some Southern climates can shut off a chiller for over 25% of the year, especially if the system's setpoint is optimized for the facility and the climate.
- Do you have the space available outside of your facility for the additional equipment?
  - Depending on the capacity of the cooling system, the fluid cooler can require a fair amount of real estate.
- Are your facility and process equipment capable of supporting a glycol/water process fluid?
  - Some processing equipment cannot tolerate glycol. Also, glycol management adds more handling requirements for your facility staff.
  - This is when a full divider in your pump/tank may be useful.

You can review all of these items and more with a professional application engineer. They will guide you through the process to understand your particular needs and tailor a system to maximize your energy savings while minimizing your upfront costs. **BP**

#### About the Author

*Tom Stone is the National Sales Manager of Industrial Markets for Thermal Care. He has been in the process cooling field for 14 years after graduating from Purdue University's School of Mechanical Engineering. For more information visit <https://www.thermalcare.com>*

To read similar articles about **Free-Cooling System Assessments** visit <https://coolingbestpractices.com/system-assessments/free-cooling>



## Boston Hospital Cuts Energy Bills 33% with Chiller Optimization Solutions

By Eddie Rogers, tekWorx

*Chiller plants are the largest single consumer of energy in most health care facilities.*

► Hospitals account for nearly 5% of the total energy use in the United States each year. The average 200,000 ft<sup>2</sup> facility spends about \$13,600 per bed, or roughly \$680,000 annually, on energy costs. Why so much? Operating twenty-four hours a day, thousands of employees, patients, and visitors cycle through campus buildings daily. Additionally, hospitals maintain high ventilation rates to lessen the risk of microbial contamination; the conditioning requirements of this outdoor air represents significant energy usage. Lastly, the use of sophisticated imaging equipment, electronic health record systems and other operations generates heat that must be compensated for via the site's cooling load.

Hospital cooling, therefore, bears the brunt of this utility usage as chiller plants are the single largest consumer of energy in most health care facilities. This consumption can be made even more extreme if the system is not designed to operate at its maximum efficiency.

It is no surprise then that hospital operations teams are continually seeking to improve energy efficiency and reduce operating costs. While regular and scheduled HVAC maintenance, daylighting, and automatic controls or sensors can reduce energy costs, these low-hanging fruits eventually get picked. Optimizing the chiller plant is one of the greatest means of short and long-term

reduction of energy use for large health care systems. Such was the case with a Northeast hospital that wanted to save on utility costs and use less water.

### Background

A leader in virtually every area of medicine, a Boston-area hospital has long been the site of pioneering breakthroughs that have improved lives around the world. A nearly 800-bed teaching affiliate of a prestigious medical school, the facility is recognized internationally for its excellence and innovation in patient care, biomedical research, education, and training. Knowing that chilled water production was a major energy user, the operations and

energy team sought the assistance of outside consultants to help them navigate the world of energy optimization solutions.

Having reviewed tekWorx successful energy optimization projects elsewhere, the hospital project team commissioned tekWorx to perform an energy audit on the hospital's cooling system. The comprehensive energy audit gave the hospital a clear picture of the existing system. Specifically, the audit assessed how the cooling system and equipment were being used, how these systems and machines either did or did not work together, how current operation strategies were impacting energy performance, and what pragmatic solutions could be implemented that would both reduce consumption and pay back quickly.

The 2,400-ton chilled water plant was designed in an efficient Variable/Primary configuration but the chilled water supply temperature setpoints and condenser water supply temperature setpoints were both set to static points all year, regardless of actual conditions. The audit also showed that while the chilled water pumps were variable speed, they were observed on-site to be operating as constant speed pumps. This excess flow was wasting pump power and added unnecessary head to the system. An Invensys building automation system (BAS) controlled all chilled water plant equipment. While in relatively good condition, it lacked an optimization sequence.

Upon reviewing these findings, tekWorx and the hospital team agreed that the comprehensive Xpress® chilled water plant optimization solution would address the identified hydronic, mechanical and control issues while significantly improving overall HVAC efficiency.

### Approachable Expertise

tekWorx installed its Xpress® solution, a combination of adaptive control algorithms and Tridium Niagara N4 hardware, to optimize the hospital's chilled water plant equipment in real-time. These optimization algorithms continuously adjust equipment sequences and key setpoints based on such parameters as occupancy level and outdoor temperature to continually maximize the system efficiency while maintaining space cooling conditions throughout the hospital, including operating rooms.

The hospital elected to integrate the tekWorx Xpress® system with the Invensys BAS utilizing a local, on-site BACnet-based supervisory architecture. In this implementation option, the BAS remains physically connected to all operating equipment (chillers, pumps, cooling towers, valves, etc.) and instrumentation such as flow meters, temperature and pressure sensors, and kW sensors.

Xpress® and the Invensys system work together in two operating modes to control and optimize the hospital's cooling system operations – Local Control Mode and Optimization Mode. While in the Local Control Mode, the BAS uses its existing “make-it-work” control program to operate the cooling system in the same sequence as it always

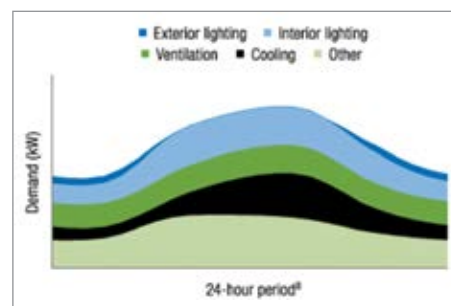

Profile of electricity consumption at the hospital.

had with no efficiency input from Xpress®. When the Optimization Mode is active, the BAS continuously sends operating equipment data and process signal values to Xpress® for use in its patented optimization algorithms to calculate operating equipment sequence instructions and setpoints that maximize overall system efficiency (minimize kW/ton). These instructions are then sent to the BAS which executes the corresponding control instructions. Xpress® built-in communication watchdog, system heartbeat, and bumpless transfer functions ensure safe and seamless transition between these modes. In the event of a maintenance override or a communication interruption, the systems automatically revert to Local Control Mode so that the BAS program continues to operate the system and produce cooling until the fault is cleared or the maintenance is completed.

### Architecture Advantages: Owner and Integrator

The hospital selected the Xpress® supervisory architecture because it ensures the cooling system reliability that is so critical for a facility with 24-hour patient needs, including operating rooms, that may be pressed in to service at a moment's notice. At the same time, this architecture simplifies the BAS integrator's task and maintains use of the existing sequence which has already been tested. The Xpress® user interface makes all optimization-related parameters accessible for any future service, and it provides operators with a both historical and holistic views of system performance.

### Optimization in Action

An example of the equipment sequence optimization instruction might involve Xpress® telling the Invensys BAS when to add or remove a chiller so that all operating

## Boston Hospital Cuts Energy Bills 33% with Chiller Optimization Solutions

chillers will run at their most efficient operating points. The BAS corresponds by controlling the valves and pumps and monitors the flow/pressure signals values to verify the minimum condenser and evaporator flows before turning the chiller ON or OFF. In an example setpoint optimization instruction, Xpress® sends a new setpoint to adjust the remote differential pressure for the hospital's chilled water distribution loop based on real-time conditions. The Invensys system then uses the new setpoint in its PID loop algorithm to control the pump speed to achieve that optimized setpoint. Xpress® optimization instructions continuously work with the existing BAS system and equipment to minimize the hospital's overall system kW per ton.

### Tracking the Improvement

In addition to the control updates, the other major factor in this efficiency upgrade was the implementation of the Xpress® Energy Efficiency Dashboard. Many hospitals are built over time, creating a mixture of fixtures, equipment, management systems, and documentation. As a result, getting a clear window into real-time operations can be difficult. The hospital staff can now clearly view Key Performance Indicators (KPIs) such as kW and kW/ton performance for each piece of major equipment as well as those of the total chilled water system in one, single interface. In addition, the operations staff can customize these KPIs to address their needs. Real-time energy performance can be displayed relative to historical data and trending capabilities

to provide staff with an instant look at the long-term view of system performance. This interface also allows the hospital team to have an instant snapshot of energy consumption, power consumption and utility costs to better understand usage and identify energy waste and equipment problems.

### Single Year Payback

The seamless implementation of Xpress® has reduced the facility's cooling costs by a third annually while earning the site a \$31,000 utility rebate. With a simple payback of one year, the initial project outlay was quickly re-invested back into the institution to finance investments in improving patient care and other more capital-heavy facility needs.

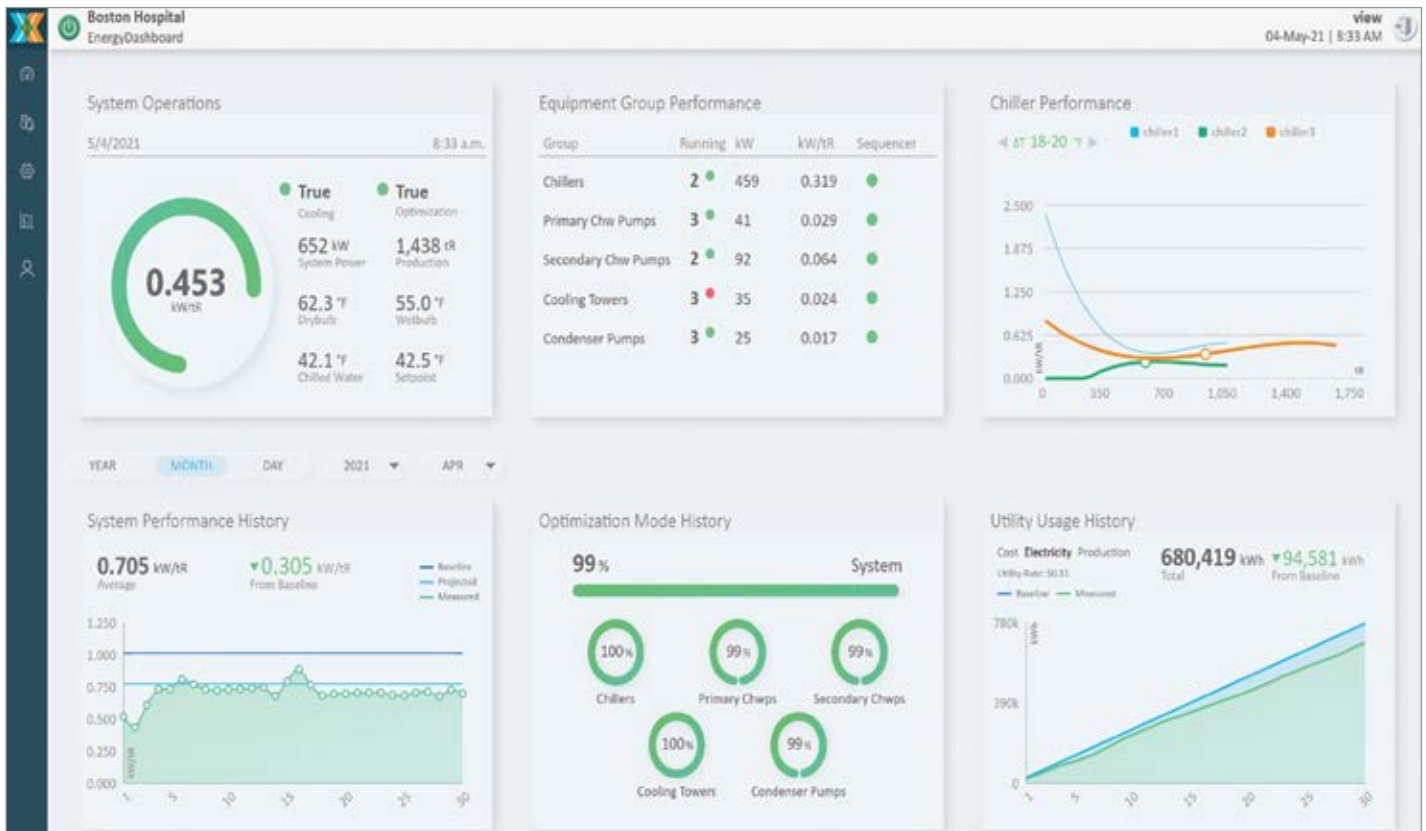

Energy consumption dashboard at the hospital.

In addition to dollars, this project has had a profound environmental impact. Meeting all cooling demands but with less energy, the campus has significantly decreased its carbon footprint. The operations team estimates that two hundred metric tons of CO<sub>2</sub> emissions were saved in the first six months of operation while more nearly two million gallons of water will be saved per year.

Energy retrofits at the hospital have dramatically reduced energy consumption and cut maintenance costs, all while improving equipment lifetime and correcting deferred maintenance problems. The Xpress<sup>®</sup> system is no exception. In addition to significant energy savings, the system also

provides the operations team with real-time energy data for all chilled water equipment. Understanding how energy is used can help quickly identify energy waste and equipment problems, as well as overcharges and errors on energy bills. Xpress<sup>®</sup> also acts as an early warning system, sending emails or texts to staff when equipment such as a fan, pump or chiller is operating outside expected parameters. Facilities and operations staff are also freed up for other tasks, increasing their bandwidth and response time.

Consistently ranked by *U.S. News & World Report* as one of America's Best Hospitals, this campus has long been a proponent of progress and technological advancement. Expanding that focus to energy consumption has not only helped the hospital operate more efficiently but allows the site to continue offering cutting-edge care with a lesser environmental impact. **BP**

For more information visit <https://www.tekworx.us>

To read more articles on **Chiller Technology** visit <https://coolingbestpractices.com/index.php/technology/chillers>



**Worried About Moisture & Oil Contamination in Food Production?**

**Learn Quality & Safety Best Practices – View Our FREE\* On-Demand Webinars & Articles**

**Library of Food Safety Webinars Includes**

- Safety and Quality in Compressed Air: Why You Should Care
- Integrating ISO 8573-1 Compressed Air Quality Classes into SQF Food Safety Certification
- Safe Quality Food Standard: 5 Compressed Air Criteria
- Global Food Safety Initiative (GFSI) Compliance: Two Compressed Air System Specifications

**Library of Food Safety Articles Includes**

- Compressed Air GMPs for GFSI Food Safety Compliance
- Sampling and Testing for Compressed Air Contaminants
- Unilever Ice Cream Plant Reduces Compressed Air Consumption
- Keep Contaminants Out of Food & Bev Processing Air Supplies

\*Included with your free magazine subscription



**Get FREE Instant Access\* to Webinars & Articles >>>**

<https://airbestpractices.com/magazine/webinars> • <https://airbestpractices.com/industries/food>  
<https://airbestpractices.com/standards/food-grade-air>

# Ice Storage or Chilled Water Storage? Which Is Right for the Job?

By Paul Valenta, Trane

*Cool storage offers a reliable and cost-effective means of cooling facilities – while at the same time – managing electricity costs. Shown is a 1.0 million gallon chilled water storage tank used in a cool storage system at a medical center. (Image courtesy of DN Tanks Inc.)*

► One challenge that plagues professionals managing large facilities, from K-12 schools, colleges and offices to medical centers, stores, military bases and data centers, is finding a more cost-effective, environmentally friendly strategy for using and consuming energy. This problem is compounded by the fact that the cost of electricity is at its highest during the day, when demand for power is at its peak. As a result, storing less expensive off-peak electricity has been a viable solution for many firms and institutions.

The U.S. Energy Information Administration noted that nearly 40%<sup>1</sup> of the electricity consumed by commercial facilities in the United States is dedicated toward heating, ventilation and cooling systems. As a result,

addressing the costs associated with cooling a facility has huge potential for generating cost-savings and decarbonization. Specifically, a “buildings’ ability to shift energy demand away from peak periods, such as on hot summer afternoons, can greatly reduce both cost and GHG emissions by allowing utilities to reduce the need for their least efficient and most polluting power plants... and mitigating problems associated with the intermittent output of wind and solar energy systems,” according to the Department of Energy.<sup>2</sup>

## Managing Costs with Cool Storage Technology

A technology called, “cool storage” offers a reliable, cost-effective means of managing electricity costs while ultimately helping

to limit greenhouse gas emissions. The technology allows facilities to take advantage of less costly electricity available at night and functionally save that energy for use at a later time. Cool storage achieves this performance by using ice or chilled water as a medium for storing and deploying energy.

The right time to decide on cool storage varies, but may be most attractive when at least one of the following are present:

- It’s time to invest in a chiller plant.
- Back-up cooling is needed.
- Increased cooling loads.



- Reaching electrical service limit.
- Limited space for fans and ducts require colder air temperature applications.
- The facility is seeking to reduce its environmental impact.
- The building has a poor load factor (peak load is higher than the average load).
- The utility offers favorable rates. Many utilities charge peak demand charges that can make up 30 to 70 percent of a building's electric bill<sup>3</sup>.

### Chilled Water and Ice Storage Each Offer Unique Benefits

Each facility has its own unique energy needs and challenges to contend with. That's why there are multiple strategies for cool thermal energy storage solutions on the market. Ice storage and chilled water storage make up the two most prominent technologies available – taking a closer look at the advantages of each strategy will reveal which application is the best fit for an organization interested in deploying energy storage.

Ice storage and chilled water have plenty in common. Both are reliable energy storage solutions that have been deployed for decades, and both are capable of making it easier for facilities to efficiently operate their cooling systems. Both have superior benefits over traditional cooling. They offer energy costs savings, back up cooling capacity, may extend an existing system capacity at less cost than conventional non-storage, make renewables more viable, reduce greenhouse gas emissions and lower transmission line losses. On average 5%<sup>4</sup> of the electricity traveling across the grid can be lost by inefficiencies in the system and



*A cool thermal energy storage system uses stored ice or chilled water as a medium for deploying energy. (Image courtesy of Trane.) There is hot and cold thermal energy storage. Hot TES would include the water heater in your home. This article focuses on cool thermal energy storage including chilled water storage and ice storage.*

can go higher during the summer daytime periods. Storing energy at night and then cost-effectively deploying cool thermal energy storage during the day puts less pressure on the grid – the system is most vulnerable during peak demand periods when an entire region attempts to draw power at the same time.

### Evaluating Cool Thermal Storage Technology

Ice storage and chilled water technologies also have a long list of differences with regards to the installation process, design parameters, expected long-term maintenance and operating cost-savings.

Facility managers should think through a few of the following considerations as they evaluate the advantages each cool thermal storage technology can bring to the table:

**Markets** – Both chilled water and ice storage work for large facilities such as schools, hospitals and offices. If the building has loads with a very short duration (30 minutes to 2

hours) then chilled water storage may be a better choice due to the quicker discharge rates. Data centers where there is sufficient space for a large tank (3,000 tons and up) would be a great fit for chilled water storage. Whereas, ice storage would be a better applied on large and taller multi-story buildings, chilled water storage tanks operate at atmospheric pressure, complicating the interface with pressurized building piping.

**Siting locations** – Where can the storage system be located? Ice storage may be buried, put on roofs, placed indoors, in the basements or outdoors. Chilled water storage is mostly sited outdoors, and can be above ground or buried, however may not be applied on roofs due to its mass and largely due to atmospheric pressure limits.

**Expansions and permanence of installation** – Does building ownership anticipate eventually changing location chosen for storage tank deployment or adding additional cooling capacity? If so, it makes sense to compare the installation permanence

## Ice Storage or Chilled Water Storage? Which Is Right for the Job?

of ice storage and chilled water applications. Ice storage tanks like Trane® Ice Bank® units are modular and re-deployable, making it a simple task to change their location with respect to the needs of the business while conveniently staying as a permanent structure for the life of the system if needed. Modular ice storage tanks can be easily added to an existing ice storage facility.

A chilled water tank, on the other hand, is only designed to be a permanent structure and may be considered if storage locations are expected to stay consistent for the foreseeable future.

**Retrofits** – Most screw and scroll chillers can produce ice making temperatures with very few exceptions. If the facility only has centrifugal compressors that have NOT been designed to produce ice making temperatures and has no plans to add new chillers, the energy storage design would lean towards chilled water storage. Any type chiller can be used with chilled water storage including existing centrifugal chillers.

**Tank size** – What kind of space is available for installation? Chilled water storage tanks are significantly larger than those used for ice applications like Trane Ice Bank® tanks. Typically, chilled water installations are sized

anywhere from 8 to 10 times larger than ice tanks, often approaching 30 feet or taller in height. By comparison, some tanks stand at just 8-and-half feet tall, providing much more flexibility during the installation process. The shorter tank size is preferable for indoor applications as well as outdoors.

**Short and long-term value** – How does an organization's ownership experience differ depending on the cool thermal storage solution chosen for deployment? The first costs of ice and water systems should be compared. In smaller (< ~ 10,000 ton-hours), ice storage can be installed for less \$/ton-hour than water storage. With larger installations, water storage can be less expensive.

Once at the end of the product life cycle, large water storage tanks can be a stranded asset, i.e., not used at another location. Ice storage may be reused and installed at different facilities.

**Performance and reliability** – What does the track record of an energy storage tank provider communicate about the performance of their technology? Of importance is a long history of successfully designing and installing cool thermal storage solutions. A diverse portfolio of projects also makes it simple for building ownership to identify a frame

of reference and estimate the potential advantages of thermal storage applications.

**Construction** – How quickly do you need your energy storage system up and running? Do you need to deploy a simple, fast installation or are you prepared for a more complex project? Ice storage tanks can be easily installed and operating in less than one week. Many chilled water storage solutions, on the other hand, are architecturally challenging, making it difficult to site large tanks and may require months of construction. Companies are needed to civil engineer the project, including testing load-bearing capability of the ground. Chiller water storage projects are handled by multiple companies that develop the storage tank, control systems and coordinate installation. Accounting for the reliability of each component is more difficult and time consuming than investing in a single predictable system.

**Ease and cost of maintenance** – Will the maintenance of a cool thermal storage system impact the ownership experience? Building managers are tasked with keeping HVAC systems performing at optimal levels and will be responsible for keeping an eye on the organization's energy storage applications as well. The simpler a system is the better, as there are fewer opportunities for components to age or become damaged. Some chilled water tanks (concrete type) are built to require virtually no maintenance. Also, a company with a single-source provider eases not just the purchase but any commissioning and maintenance.

In the case of ice thermal storage, some energy storage tanks are built to minimize the amount of water that needs to be treated and reduce the volume traveling between the tank and the building. Other maintenance considerations may include the number of tanks and size.



There are different types of cool thermal storage technologies, including ice storage and chilled water technologies. Ice storage including the Trane® Thermal Battery™ air-cooled chiller plant is shown here. (Image courtesy of Trane.)



Cutaway of a CALMAC® Ice Bank® energy storage tank. (Image courtesy of Trane.)

**System design** – Is series architecture important to your chiller plant design? Chilled water storage systems operate the ice and chiller at the same time with flow for charging and discharging traveling back and forth within the same piping. This flow reversal for charge/discharge is awkward and may be complex to design. Whereas, in an ice storage system flow travels in only one direction and series configurations are possible allowing for flexible configurations to take advantage of utility rate structures.

For systems designed for a larger delta T, lower temperature requirements can offer the greater benefit. Low temperature coolant from ice systems can provide wider delta T's, increasing pumping efficiency. Installed costs for piping and pumps are significantly less due to less flow and extra energy used to make the ice. Plus extra energy needed to make ice may be offset by less pumping energy. In a chilled water storage system, low ice temperatures are not feasible, however wide delta T's are still possible. For optimal efficiency it is critical to maintain system delta T at all load levels. Any water that returns to

tank below design temperatures represent lost storage capacity.

### Two Sides of the Same Coin

Both ice and chilled water storage have their merits. Chilled water storage can be incorporated into a fire protection system and is more suitable for data centers due to fast discharge rates. Also, chilled water storage plants don't need to produce ice making temperatures, so existing centrifugal machines that aren't ice ready can be used. On the other hand, Ice storage arrives factory assembled and installs in far less time than chilled water storage.

In larger installations, chilled water storage can be less expensive, even though it takes longer to install. Ice storage can pay back in as little as three to five years, requires less space, is modular, reusable and simple to maintain and control. You have the flexibility to run the ice and chiller at the same time or run just one or the other and at the end of the system life, it's a non-stranded asset.

Yet despite all their differences, no matter which solution is chosen, cool storage shares many powerful benefits and fundamentally changes how and when facilities draw electricity from the grid. More efficient lights and equipment, daylighting and fans are all great ways for facilities to improve efficiency, however, reducing peak demand by storing energy for when you need it is just as important. In fact, cool storage is such a novel

solution because it allows building managers to fundamentally change how and when the facility draws electricity from the grid, slashing cooling costs and leveling loads for greener, smarter buildings. **BP**

All trademarks referenced are trademarks of their respective owners.  
© 2021 Trane. All Rights Reserved.

### About the Author

Paul Valenta serves as the North America product manager for Trane's CALMAC® energy storage portfolio. He is responsible for bringing ice thermal energy storage products and systems to market. Valenta graduated from the University of Nebraska with a Bachelor of Science in Electrical Engineering and is also member of ASHRAE® and USGBC®. In 1991, he began working with CALMAC and now has over 30 years of energy storage experience. Valenta grew up in North Dakota, so he knows what cold can do. Email: Paul.Valenta@tranetechnologies.com.

### About Trane

Trane® is a world leader in air conditioning systems, services and solutions. Trane helps customers succeed by providing innovative solutions that optimize indoor environments through a broad portfolio of energy-efficient heating, ventilating and air conditioning systems, building, contracting and energy services, parts support and advanced controls for homes and commercial buildings. For more information, visit [www.trane.com](http://www.trane.com).

All photos courtesy of Trane and DN Tanks.

### Endnotes

- 1 EIA. Use of Energy Explained. Sept 28, 2018. <https://www.eia.gov/energyexplained/use-of-energy/commercial-buildings-in-depth.php>
- 2 DOE. AN ASSESSMENT OF ENERGY TECHNOLOGIES AND RESEARCH OPPORTUNITIES. Sept 2015.
- 3 National Renewable Energy Laboratory. Identifying Potential Markets for Behind-the-Meter Energy Storage: A Survey of U.S. Demand Charges. Aug 2017.
- 4 EIA. How much electricity is lost in electricity transmission and distribution in the United States? Dec 31, 2019.

To read similar **Chiller and Cooling System Assessments** articles, visit <https://coolingbestpractices.com/system-assessments>

# BEST PRACTICES

2021 EXPO NOVEMBER 2-4 CHICAGO, IL  
COMPRESSED AIR / VACUUM / COOLING



## OPTIMIZE ON-SITE UTILITIES

### Powering Automation

Research and Identify Innovations  
to Enhance the Efficiency and Reliability of Your Systems

#### Compressed Air

Air Compressors  
Air Compressor Controls  
Air Purification & Piping  
Condensate Management  
Pneumatics

#### Blower & Vacuum

Aeration Blowers  
Industrial Blowers  
Vacuum Pump Systems  
Inlet Filtration/Oil Separators

#### HVAC & Process Cooling/Steam

Chillers  
Heat Exchangers  
Cooling Systems  
Cooling Towers  
Water Treatment  
Boilers  
Steam Traps

Motors & Drives • Lubricants • Measurement Instruments • IoT Automation & Monitoring

### EXPO HOURS

Tuesday, November 2 12:00-6:00PM

Wednesday, November 3 12:00-6:00PM

**SAVE THE DATES ON YOUR CALENDAR!**  
Located at the modern Schaumburg Convention Center  
just 10 minutes from Chicago O'Hare International Airport.

[cabpexpo.com](http://cabpexpo.com)

Sponsored by



# COMPRESSED AIR INDUSTRY & TECHNOLOGY NEWS

## Atlas Copco G 2-7 Range

Atlas Copco Compressors announces the G 2-7 launch, a new range of 3-10 horsepower rotary screw air compressors.

The G 2-7 comes equipped with a premium efficiency motor, a new in-house designed state-of-the-art low-vibration screw element, and an Elektronikon® Base controller. Together, these create a robust, supremely efficient, easy-to-use, quiet point-of-use compressor range. The G 2-7 models are Atlas Copco's smallest rotary screw compressors, ideal for general manufacturing, garages, workshops, and operations with changing compressed air demands that are looking to expand. Though small in size, the G 2-7 range offers significant benefits. Due to the premium motor and new proprietary element, the G 2-7 delivers Atlas Copco's unrivaled efficiency. This not only lowers operating costs but also reduces emissions for a smaller carbon footprint.



Atlas Copco Compressors, [www.atlascopco.com/air-usa](http://www.atlascopco.com/air-usa)

## Ingersoll Rand MSG TURBO-AIR NX 5000 Centrifugal Compressor

Ingersoll Rand has released the new Ingersoll Rand® MSG® TURBO-AIR® NX 5000, an oil-free air and nitrogen compressor that provides manufacturers and producers improved total cost of ownership through optimized energy efficiency and operational flexibility. The MSG TURBO-AIR NX 5000 compressor generates 100% oil-free air or nitrogen that meets ISO 8573-1 standard. Its long life, easy maintenance and ability to adapt to a wide span of air capacity requirements make the TURBO-AIR NX 5000 a fit for instrument and process applications in food and beverage, pharmaceutical, petrochemical, oil and gas, steel and iron, pulp, paper and textile production.



Ingersoll Rand, [www.IRco.com](http://www.IRco.com)

## Kaeser DC-HF Desiccant Dryers

Announcing Kaeser's new DC-HF series of compact desiccant dryers for point of use or other low flow applications from 7 to 40 scfm and pressures from 58 to 218 psig. These heatless, twin tower regenerating dryers are ideal for sensitive applications that require pressure dew points from -40°F to -94°F. All DC-HF dryers now include the Eco-Control Smart controller with Modbus TCP communications, remote on/off control, maintenance timers, and operational displays. DC-HF dryers also feature operating modes which reliably meet required pressure dew points in either a fixed cycle or with the optional demand-based PDP control kit. With easy installation as floor or optional wall-mounted units, the DC-HF dryers feature aluminum desiccant cartridges, purge solenoid valves, and maintenance-free shuttle valves.



Kaeser Compressors, [us.kaeser.com](http://us.kaeser.com)

## Parker PSE Series Cycling Refrigeration Dryers

Industrial Gas Filtration and Generation Division of Parker Hannifin Corporation announces the launch of its new Parker PoleStar Smart-E Series cycling refrigerated compressed air dryer with low GWP refrigerant, R513A. Compared to current Hydrofluorocarbons refrigerants, such as R134a and R407C, R513A is a Hydrofluoroolefin with a remarkably low global warming potential of 573. This HFO refrigerant has no stratospheric ozone impact and is both non-toxic and non-flammable. Parker's PSE replaces their current refrigerated dryer offering for ranges 325-6,000 scfm, the DRD Series. Like DRD, the PSE offers SmartCycle energy-saving technology standard on all models, which delivers lower average absorbed power than non-cycling designs and comparable energy savings to other cycling designs. Utilizing Parker's state-of-the-art 4-in-1 aluminum heat exchanger with oversized cross flow design, the PSE reduces energy consumption while delivering industry leading pressure drops.



Parker, [www.parker.com](http://www.parker.com)

# COMPRESSED AIR INDUSTRY & TECHNOLOGY NEWS

## Hertz Kompressoren Celebrates Five Years in USA with New COO

Hertz Kompressoren is a fast-growing name in the compressed air industry. This year, Hertz Kompressoren USA is celebrating five years of business after having brought the brand, to the United States in 2016. As the company steps across this momentous threshold, we take a moment to remember their beginnings, and look out into their future. In the land of opportunity, Hertz has leveraged its excellent customer service, positive company culture, and dedicated and specialized staff to take itself from a lesser-known name to a competitive force in the US market in just five years. Integral to building those core values, which have brought Hertz so much success, has been their Chief Operations Officer, Stephanie Brockman.



Hertz Kompressoren USA, [www.hertz-kompressoren.com](http://www.hertz-kompressoren.com)

## Fluke Non-Contact Voltage Clamp Meters

Any time an electrician or technician makes a voltage measurement on a live conductor, there is a risk of electrical shock. The new Fluke 377 FC and 378 FC Non-Contact Voltage True-RMS AC/DC Clamp Meters minimize this risk because they are the only clamp meters that make accurate non-contact voltage measurements without test leads. The Fluke 377 FC and 378 FC True-rms clamp meters use Field-Sense technology to make testing faster and safer, all without touching a live conductor. You get accurate voltage and current measurements through the clamp jaw. Simply clip the black test lead to any electrical ground, put the clamp jaw around the conductor and see reliable, accurate voltage and current values simultaneously on the dual display. Both clamp meters offer complete 3-phase voltage and current tests in three quick steps.



Fluke, [www.fluke.com](http://www.fluke.com)

## ENMET GSM-60 Air Quality Multigas Monitor

GSM-60 is an excellent solution for identifying indoor air quality issues. This ambient air monitoring system is designed for both simple indoor air quality monitoring and for difficult environments, including headspaces of tanks, HVAC ductwork, VOC scrubber exhausts and wastewater treatment plants. GSM-60 is used in a variety of industrial applications from medical and pharmaceutical to aerospace and process manufacturing. The system features an internal sampling pump with the capability of using both internal and remote sensors to continuously monitor up to four gases. The instrument has user programmable alarms with relays that can activate remote safety or warning equipment such as exhaust fans, alarms or strobe lights. GSM-60 can be configured to monitor a wide range of chemicals in ambient air including VOCs, carbon monoxide, carbon dioxide and oxygen, as well as many toxic and industrial gases.



ENMET, [www.enmet.com](http://www.enmet.com)

## La-Man Refrigerated Extractor Dryer

La-Man Corporation offers a series of Refrigerated Air Dryers to provide reduced dewpoint temperatures and air line filtration for a wide variety of compressed air applications. The Refrigerated Air Dryer from La-Man Corporation uses a unique 3-in-1 heat exchanger to first pre-cool the air, second to refrigerate the air to condense out all liquid vapors, and third returns heat to the air to prevent downstream pipe sweating and condensation. Product features include an On/Off switch, Power on Light, Dewpoint Indicator, Programmable Timed Solenoid Drain, quiet operation and compact footprint. Maximum Inlet Pressure is 232 PSI. In addition to the series of Refrigerated Air Dryers, other compressed air filtration products are available from La-Man Corporation including the Extractor Dryer, the SuperStar .01 Micron Filter, the AMD Series Membrane Dryers, the Pneuguard In-line Dryers and Lubricators, and Breathing Air Systems.



La-Man Corporation, [www.laman.com](http://www.laman.com)

# CHILLER & COOLING INDUSTRY & TECHNOLOGY NEWS

## VSD Air-Cooled Screw Chiller with Evaporative Pre-Cooling

Carrier has announced the availability of evaporative pre-cooling technology on Carrier's AquaForce 30XV variable-speed air-cooled screw chiller product line. This technology harnesses the power of evaporation to lower ambient air temperatures entering Carrier's 30XV chiller – helping to reduce chiller power consumption, increase reliability and extend the life of the chiller. Evaporative pre-cooling technology works by spraying a fine mist of water within patented, pre-cooling frames, which are attached to Carrier's 30XV chiller. As air is pulled across the pre-cooling frames and into the chiller, the outside air is cooled via evaporation. This technology operates using a sophisticated controller employing algorithms that spray the least amount of water needed to achieve optimal evaporation, thus delivering the highest energy savings with the lowest water usage.



Carrier, [www.carrier.com](http://www.carrier.com)

## Microchannel Heat Exchangers for R1234ze and R515B

Danfoss has expanded its popular range of microchannel heat exchangers, with a new version optimized for use with low-density, low-GWP refrigerants like R1234ze and R515B. The new, world-first technology solves a key design challenge for OEMs transitioning to ultra-low GWP refrigerants such as R1234ze and R515B – especially in large air-cooled chillers using screw and centrifugal compression. Typically, the low density of these refrigerants makes system performance highly sensitive to pressure drops. But thanks to optimized micro-channel tube geometry, the new, optimized microchannel heat exchangers (MCHEs) provide the ideal balance between maximum heat rejection and internal refrigerant pressure drop. As a result, OEMs can realize a 20% reduction in refrigerant pressure drop at the component level and transition more easily to low-GWP, low-density refrigerants.



Danfoss, [www.danfoss.com](http://www.danfoss.com)

## Rooftop HVAC System with Inverter Scroll Compressors

Daikin Applied announced updates to its Rebel Applied packaged rooftop HVAC system, known for its leading airflow and efficiency ratings, and compact footprint. Rebel Applied now comes with inverter scroll compressors, precision temperature and humidity control, and adaptive refrigeration technology, expanding its ability to provide unmatched energy efficiency and enhanced indoor comfort. Driven by Daikin inverter technology, these new features boost Rebel Applied's already best-in-class efficiency. Unlike staged compressors that operate at fixed points, the inverter technology modulates compressor and cooling capacity continuously from 100% down to 15% so the system dynamically responds to match the load of a building. This means constant temperature and humidity control, which helps reduce energy use and operating costs while enhancing occupant comfort. The addition of adaptive refrigerant control also allows Rebel Applied to intelligently manage refrigeration cycles to keep the system online and operating safely.



Daikin Applied, [www.daikinapplied.com](http://www.daikinapplied.com)

## HVACR Variable Frequency Drives

Emerson announced the introduction of its Copeland commercial HVACR variable frequency drives. They are specifically engineered to save energy in a variety of demanding commercial and industrial refrigeration applications. Adding a VFD to control the speed of a compressor, evaporator or condenser fan in applications such as a refrigeration rack or chiller can enhance overall system reliability and provide significant energy reductions, delivering quick return on investment for users in this space. When applying Copeland commercial HVACR VFDs to equipment, the same work gets done using less energy: 15 to 30% energy savings can be achieved compared to running a fixed-speed compressor or general duty motor. When a drive is applied to a fan or pump, the motor speed for those applications can be modulated from 10 to 100%.



Emerson, [www.emerson.com](http://www.emerson.com)

# CHILLER & COOLING INDUSTRY & TECHNOLOGY NEWS

## Commercial Rooftop Units Expanded to 80 Tons

Johnson Controls expanded its line of premium commercial rooftop units, which are now available in 25-80 tons. The Johnson Controls Premier platform provides building owners with best-in-class efficiency levels that significantly reduce operational costs over the life of the unit, while ensuring indoor air quality is maximized through optional features such as ultraviolet lights, humidifiers and final filters. The Premier platform meets aggressive Department of Energy 2023 energy efficiency standards. Offered in standard efficiency, high capacity or high efficiency, Premier units can provide up to 50% greater efficiency at part-load than is required, depending on the standard. Standard double-wall foam panels offer improved thermal efficiency, while modulating options, such as compressors, an energy recovery wheel, and gas or electric heat, further improve efficiency, providing quality comfort.



Johnson Controls, [www.johnsoncontrols.com](http://www.johnsoncontrols.com)

## Johnson Controls Selects R-454B for Air-Cooled Scroll Chillers

After extensive research, testing and evaluation, Johnson Controls has selected R-454B, a lower global warming potential (GWP) refrigerant, to replace R-410A in its ducted residential and commercial unitary products as well as air-cooled scroll chillers. This decision was made as the HVAC industry is preparing to phase out high-GWP refrigerants, such as R-410A, which are now being formally addressed by the Environmental Protection Agency through the recently passed American Innovation and Manufacturing Act. The AIM Act directs the EPA to phase down U.S. hydrofluorocarbon production and use by approximately 85% over the next 15 years. After evaluating several low-GWP alternatives on a variety of performance and market metrics, such as safety, capacity, efficiency, reliability, availability and longevity, Johnson Controls has determined R-454B to be the best-in-class replacement refrigerant – a decision echoed by other leading HVAC manufacturers.

Johnson Controls, [www.johnsoncontrols.com](http://www.johnsoncontrols.com)

## Separator System for Cooling Towers

Brentwood announced the introduction of its all-new separator system, designed for use in counterflow and crossflow cooling tower applications. This system complements many other cooling tower products Brentwood supplies to the industry, including fills, drift eliminators, and inlet louvers. It's designed to remove troublesome solids, dirt, and debris from the tower basin or cooling loop. Those organics and sediment that enter the tower through the air inlets or make-up water are the leading cause of early fill replacement, poor tower performance, and downstream equipment efficiency losses. The Brentwood Separator System boasts a centrifugal separator that efficiently removes most of the suspended solids that lead to fouling in the process cooling loop. This means no more shoveling mud out of the tower basin or worrying about fouling of cooling tower fill or downstream process equipment.



Brentwood, [www.brentwoodindustries.com](http://www.brentwoodindustries.com)

## Chiller Monitoring Software Service Option

Delta T Systems introduced DTS Smart Connect, a process monitoring software service option designed to facilitate remote chiller management and servicing. When equipped with an upgraded, ethernet enabled controller and connected to a local ethernet network, all Delta T Systems chillers are able to upload specified process parameter data to a cloud-based server. The process data can then be retrieved from the cloud by the DTS Smart Connect application. This access makes trouble shooting quick and easy since it provides complete remote diagnosis and support. The practical benefits of this first phase product release include faster and higher quality service by fully trained Delta T Systems service technicians, elimination of third party contractors physical plant visits, increased production uptime, and lower service and maintenance costs.

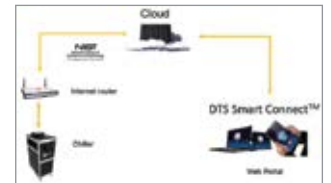

Delta T Systems, [www.deltatsys.com](http://www.deltatsys.com)



# THE MARKETPLACE

## TECHNOLOGY & JOBS

MEDICAL DEVICES:  
**EXPENSIVE**  
DRY AIR:  
**PRICELESS**



Pure-5T Regenerative Dryer  
#21999-1105-T

**TSUNAMI**  
COMPRESSED AIR SOLUTIONS

**LEAKSHOOTER®**  
The latest in Ultrasonic Leak Detection technology with embedded infrared camera

The solution in compressed air, steam trap, gas, and vacuum leak detection.

LKS1000-V3+ PRO



**B** BERG ENGINEERING & SALES COMPANY, INC.  
847-577-3980 • Info@BergEng.com  
www.BergEng.com  
Your Complete Source for Testing Equipment Since 1969!  
www.synergys-technologies.com

## COMPRESSED AIR BEST PRACTICES® www.airbestpractices.com

### ADVERTISER INDEX

Company	Page	Web Site
Kaeser Compressors	Outside Back Cover	<a href="https://us.kaeser.com/cabp">https://us.kaeser.com/cabp</a>
Atlas Copco	Inside Front Cover	<a href="http://www.atlascopco.com/air-usa">www.atlascopco.com/air-usa</a>
BEKO Technologies	Inside Back Cover	<a href="http://www.bekousa.com">www.bekousa.com</a>
Mikropor	5	<a href="http://www.mikroporamerica.com">www.mikroporamerica.com</a>
Sullair	7	<a href="http://www.sullair.com">www.sullair.com</a>
Hertz Kompressoren USA	9	<a href="http://www.hertz-kompressoren.com">www.hertz-kompressoren.com</a>
Sullivan-Palatek	11	<a href="http://www.sullivan-palatek.com">www.sullivan-palatek.com</a>
Aignep	12	<a href="http://www.aignepusa.com">www.aignepusa.com</a>
Clean Resources	13	<a href="http://www.cleanresources.com">www.cleanresources.com</a>
Sahara Air Products	15	<a href="http://www.saharahenderson.com">www.saharahenderson.com</a>
JORC Industrial	17	<a href="http://www.jorc.com">www.jorc.com</a>
Critical Rental Solutions	19	<a href="http://www.criticalrental.com">www.criticalrental.com</a>
Rogers KNW Series	21	<a href="http://www.knw-series.com">www.knw-series.com</a>
Augwind	23	<a href="http://www.aug-wind.com">www.aug-wind.com</a>
Air System Products	25	<a href="http://www.airsyspro.com">www.airsyspro.com</a>
ENMET	27	<a href="http://www.enmet.com">www.enmet.com</a>
Compressed Air and Gas Institute	29	<a href="http://www.cagi.org/personnel-certification">www.cagi.org/personnel-certification</a>
Compressed Air Challenge	35	<a href="http://www.compressedairchallenge.org">www.compressedairchallenge.org</a>

### CHILLER & COOLING BEST PRACTICES

Best Practices Webinars	8, 55	<a href="http://www.airbestpractices.com/magazine/webinars">www.airbestpractices.com/magazine/webinars</a>
Best Practices 2021 Expo & Conference	40, 60	<a href="http://www.cabpexpo.com">www.cabpexpo.com</a>
Danfoss	43	<a href="http://www.turbocor.danfoss.com">www.turbocor.danfoss.com</a>
Innovative Polymers	47	<a href="http://www.decaion.com">www.decaion.com</a>

Advertising/Editorial **Rod Smith** • rod@airbestpractices.com • Tel: 412-980-9901  
 Subscriptions Administration **Patricia Smith** • patricia@airbestpractices.com • Tel: 412-980-9902  
 A Publication of **Smith Onandia Communications LLC**  
 37 McMurray Rd., Suite 106, Pittsburgh, PA 15241

# THE MARKETPLACE

## TECHNOLOGY & JOBS

### High Efficiency Compressor Controllers

Control Rotary Screw, Vane, Scroll or Recip Compressors



Save Energy controlling up to FOUR compressors and qualify for Utility Rebates.

- Automatic Lead/Lag Control-up to FOUR Compressors
- Accurate Pressure Control with Pressure Transducers
- Compressors and Vacuum Pumps from 1 to 250 hp
- Automatic Lead/Lag Control for Chillers & Heat Exchangers

Standard Pneumatic Products, Inc.  
Tel: 203-270-1400 • Toll free: 800-979-9156  
Email: sales@stdpneumatics.com

[www.stdpneumatics.com](http://www.stdpneumatics.com)

### Superior<sup>®</sup> AccuTrak<sup>®</sup> Ultrasonic Inspection Systems

Quality • Performance • Value

Find Leaks  
Compressed Air  
Any Refrigerant  
Any Gas  
Vacuum

Diagnose Faults  
Valves, Motors,  
Pumps, Bearings  
Steam Traps  
Electric Arc  
Corona



AccuTrak<sup>®</sup> VPE-2000



[www.SuperiorSignal.com/CT](http://www.SuperiorSignal.com/CT)

### Storm BLOW-OFF STATIONS



## Safe De-Dusting of Employees

OSHA Compliant - only 2.5 PSI

Eliminates Misuse of Compressed Air

800.490.2401

[www.personnelblower.com](http://www.personnelblower.com)



Use coupon code **air10** for 10% off the internet price.



Engineered Purification  
Compressed Air Products  
[www.alpha-pure.com](http://www.alpha-pure.com)  
877-645-7676



### CONDENSATE DRAINS

- Timer Controlled
- Zero Loss
- Float Drains

### S520 Portable Dew Point Meter

NEW

More benefits than you expect

- PRESSURE SENSOR**  
Enables various humidity units
- DEW POINT AUDITS**  
Indication of class on display
- LOW DEW POINT**  
Measures down to -100 °C Td
- CAMERA INTEGRATED**  
Pictures for better reports
- WIRELESS PRINTER**  
Report printing on site



Measuring has never been so easy.



German Precision and Quality

**SUTO**  
[www.suto-itec.com](http://www.suto-itec.com)

### Atlas Air & Water PFE/ BFC Flow Control Valves



- 4-in-1 Flow Controller
- Multiple Pressure and Time/Date Set Points
- Modbus Communication
- 45-day Rolling Memory



[john@atlasairandwater.com](mailto:john@atlasairandwater.com)  
[atlasairandwater.com](http://atlasairandwater.com)  
612.940.9946



# What's the quality of your air?



**"Absolute knowledge – not estimates"** is the first base requirement for making the most effective quality and energy management decisions. Sensor technology and monitoring make the actual status of all compressed air parameters in your process visible. Thus your entire process chain can be monitored, and by using data logging equipment, all this information is recorded and made permanently available for detailed analysis.

The innovative and environmentally sound technologies from **BEKO TECHNOLOGIES** take your compressed air treatment to new levels of safety, efficiency and cost-effectiveness.

## WE CAN TELL YOU!

Our promise 

 +1 (800) 235-6797

 [www.bekousa.com](http://www.bekousa.com)

Truth in Compressed Air  
Reliable | Efficient | Innovative



# It's clear who the hero is.



**Successful plant operations are all about reliability and efficiency. That's why smart managers choose oil-free screw compressors from Kaeser.**

With their *Built for a lifetime* engineering, our 2-stage oil-free rotary screw compressors deliver the best combination of efficiency and reliability.

- Flows from 192 to 1,774 cfm
- Pressures from 45 to 145 psig
- Designed for lower service costs and more uptime
- Fixed or variable speed models available
- Excellent specific performance (kW/100 cfm)
- Integrated refrigerated and heat-of-compression dryer options
- Advanced control and monitoring
- Heat recovery-ready

Learn more about how Kaeser's fresh take on oil-free design reduces downtime and increases your productivity. Visit [us.kaeser.com/cabp](https://us.kaeser.com/cabp).



Where innovation  
meets reliability.

**KAESER  
COMPRESSORS**®

*Built for a lifetime.*

**Kaeser Compressors, Inc. • (866) 516-6888 • [us.kaeser.com/cabp](https://us.kaeser.com/cabp)**

The Kaeser logo is a registered trademark of Kaeser Kompressoren ©2021 Kaeser Compressors, Inc. All rights reserved. [customer.us@kaeser.com](mailto:customer.us@kaeser.com)