

# COMPRESSED AIR BEST PRACTICES<sup>®</sup>

airbestpractices.com

September 2013

## Blower Aeration for Wastewater Treatment

- 12 Black & Veatch on ASME PTC-13**
- 16 Evaluating Different Blowers on a Wire-to-Air Basis**
- 20 Advanced Automation Improves WWTP Performance**
- 38 APG-Neuros and Turbo Blower Technology**

32 WEFTEC 2013 SHOW PREVIEW



We gave blower technology an energy efficient **twist!**



## The **ZS range** of screw blowers



- 5** year element warranty
- \$0** no need to pay more for this technology
- 24/7** support
- 30%** average energy savings
- ISO 8573-1** setting a new standard in air purity

See us at  
**WEFTEC**  
October 7- 9, 2013  
Booth #4448

**Call Us:** 866-472-1013  
**Log On:** [www.encybrowsers.com](http://www.encybrowsers.com)

*Sustainable Productivity*



# Inspiring the *NEXT*...

Generation of Energy Efficient Oil-free Air Compressors

Evolution of Energy Saving Air Treatment

Air System Management Portfolio



Providing unequalled value for the discriminating consumer.



## Hitachi Cycling Refrigeration Air Dryer

- Energy savings operation to match air demand.
- Performance optimization under extreme ambient conditions.
- Digital controls that automatically manage energy consumption.



## Hitachi Efficient Air Filtration

- Designed to exceed the ISO 8573-1 standards for compressed air purity and the ISO12500 Series International standard for compressed air filter testing.
- Consistent liquid and particulate removal with low pressure losses.
- Compact modular design for easy installation in confined spaces.

## Hitachi Desiccant Air Dryer

- Integral filter and desiccant cartridges offers a space saving design for either floor or wall installation.
- PLC controls enable intermittent or continuous clean dry air.
- Optional purge saving controls with dew point sensor.



## Hitachi Air System Controller

- Efficient control of fixed speed and/or variable speed compressor systems.
- Air system management for 2 to 12 compressors.
- Optimization of control continuously selects the most efficient combination of compressors based on air demand.



# ...the *NEXT* has arrived

# SUSTAINABLE MANUFACTURING FEATURES

## 12 Q&A: Black & Veatch on the ASME PTC-13 Blower Standard

By Rod Smith, Compressed Air Best Practices® Magazine

## 16 Evaluating Different Blower Technologies on a Wire-to-Air Basis

By Andrew Balberg, Atlas Copco

## 20 Advanced Automation Improves Performance at a Wastewater Treatment Plant

By Nate Ventress, Festo

## 26 Magnetic Bearings: An Attractive Force for Energy-Efficiency

By Mark Hinckley, SKF Strategic Industries

## 32 The WEFTEC 2013 Show Preview

By Compressed Air Best Practices® Magazine

## 38 Q&A: APG-Neuros and Turbo Blower Technology

By Rod Smith, Compressed Air Best Practices® Magazine



# COLUMNS

## 5 From the Editor

## 6 Compressed Air, Pneumatics, Vacuum & Blower Industry News

## 45 Resources for Energy Engineers Technology Picks

## 47 Advertiser Index

## 49 The Marketplace Jobs and Technology



# FROM THE EDITOR

## Blower Aeration for Wastewater Treatment



Our first article is titled “Q&A with Black & Veatch on the ASME PTC-13 Blower Standard.” Julie Gass P.E. provides us with an update on the progress of this landmark energy performance test standard for all blower types. Her comment, “Blower manufacturers should be already preparing their tests booths” caught my attention. Ms. Gass further said the draft for peer review, of this standard, should be ready in time for WEFTEC.

CAGI also announced the release of its latest standard, CAGI BL 5389, *Simplified Acceptance Test of Electric Driven, Low Pressure Turbocompressor Air Blower Packages*. The standard provides a simplified, wire-to-air performance test code applicable to packaged, low pressure turbocompressors handling atmospheric air. CAGI will submit the new standard for consideration as an annex to the ISO 5389 standard that will be used throughout the world to test turbocompressor performance.

Andrew Balberg, from Atlas Copco, writes, “There are five basic blower technologies serving the water and wastewater markets: Positive Displacement Lobe Type, High Speed Screw, Multistage Centrifugal, Integrally Geared Single Stage and Gearless Single Stage “Turbo” Technologies that incorporate air or magnetic bearings.” His article discusses how to evaluate different blowers on a wire-to-air basis.

Festo provides an interesting case study from the Las Palmas, California wastewater treatment plant. Previously manually controlled, Festo helped automate the system as the filtration center’s flow capacity was expanded from 162,000 gallons per day to 288,000.

Turbo blowers have made an impact on the blower market serving the wastewater industry. In this issue we provide you with two articles on turbo blowers. One comes from SKF and is titled, “Magnetic Bearings: An Attractive Force for Energy-Efficiency”. The second is, “APG-Neuros and Turbo Blower Technology”.

WEFTEC 2013 will be held October 5-9 at McCormick Hall in Chicago. We are proud to again be a *Supporting Publication* and hope you enjoy our review (see page 32) of the blower and air compressor manufacturers exhibiting at the show.

Thank you for your support and for investing in **Compressed Air Best Practices®**. 

**ROD SMITH**

Editor

tel: 412-980-9901, [rod@airbestpractices.com](mailto:rod@airbestpractices.com)

| COMPRESSED AIR BEST PRACTICES® EDITORIAL ADVISORY BOARD |                                     |  |                           |
|---|-------------------------------------|--|---------------------------|
| Industrial Energy Managers                              | Doug Barndt                         | Manager, Demand Side Energy-Sustainability | Ball Corporation          |
|   | Eric Battino                        | Productivity Senior Manager                | PepsiCo                   |
|   | William Jerald                      | Energy Manager                             | CalPortland               |
|   | Jennifer Meier                      | Global EH&S/ Plant Engineering Manager     | Varroc Lighting Systems   |
|   | Thomas Mort                         | Global Program Manager, Energy Efficiency  | Archer Daniels Midlands   |
|   | Brad Runda                          | Global Director, Energy                    | Koch Industries           |
| Technology/System Assessments                           | David Brittain                      | Director of Engineering & Marketing        | Becker Pumps              |
|   | Richard Feustel                     | Energy Advisor                             | Wisconsin Focus on Energy |
|   | Jay Francis                         | Vice President Marketing                   | SPX Flow Technology       |
|   | Tilo Fruth                          | President                                  | Beko USA                  |
|   | Mike Gembala                        | Vice President                             | Blake & Pendleton, Inc.   |
|   | Clint Hodge                         | National Accounts Manager                  | ASCO Numatics             |
|   | Paul Humphreys                      | General Manager                            | Edmac Compressor Parts    |
|   | Jon Jensen                          | Energy Conservation Manager                | SMC Corp. of America      |
|   | Mark Krisa                          | Director Global Service Solutions          | Ingersoll Rand            |
|   | Ron Marshall                        | Customer Engineering Services              | Compressed Air Challenge® |
|   | Pierre Noack                        | President                                  | Aerzen USA                |
|   | Wayne Perry                         | Technical Director                         | Kaeser Compressors        |
| Bill Scales   | CEO                                 | Scales Industrial Technologies             |                           |
| Nitin Shanbhag  | Senior Manager, Industrial Division | Hitachi America                            |                           |
| Hank Van Ormer  | President                           | Air Power USA                              |                           |

**COMPRESSED AIR BEST PRACTICES** supports the following organizations:





# COMPRESSED AIR, PNEUMATICS, VACUUM & BLOWER INDUSTRY NEWS

## Compressed Air and Gas Institute Releases New Standard for Testing Blower Performance

The Compressed Air and Gas Institute announced the release of its latest standard, CAGI BL 5389, *Simplified Acceptance Test of Electric Driven, Low Pressure Turbocompressor Air Blower Packages*. The standard provides a simplified, wire-to-air performance test code applicable to packaged, low pressure turbocompressors handling atmospheric air. CAGI will submit the new standard for consideration as an annex to the ISO 5389 standard that will be used throughout the world to test turbocompressor performance.

In 2010, CAGI members were approached by The Consortium for Energy Efficiency (CEE) on behalf of 130 energy efficiency program administrators across the United States and Canada, (cee1.org) to address the need for increased consistency in the energy performance testing of packaged blowers used in wastewater treatment and industrial applications. In response, a working group within CAGI's Blower Section formed soon after.

The ISO 5389 standard provides an extremely detailed, complex procedure to test and rate turbocompressor blowers. The new standard provides an easily integrated, cost effective, yet highly accurate approach to testing. It is applicable to all dynamic blower packages in all industrial and municipal air applications. While the standard is intended for use with all types of turbocompressor blower packages, it will be particularly useful for machines that are manufactured in batches or in continuous production quantities.

“We developed the CAGI BL 5389 standard to meet the needs of purchasers, specifiers, and manufacturers. The standard provides a cost effective and accurate means of comparing performance among manufacturers, including specific power performance, or power used per unit of air delivered,” said Kenny Reekie, chair of the CAGI Blower Section.

The standard will be available as a free download on the CAGI website, [www.cagi.org](http://www.cagi.org). Interested parties should contact CAGI for further information. CAGI has authored standards for compressors, dryers, filters and systems that have becoming international standards used the world over.

The Compressed Air and Gas Institute is the united voice of the compressed air industry, serving as the unbiased authority on technical, educational, promotional, and other matters that affect compressed air and gas equipment suppliers and their customers. CAGI educational resources include e-learning coursework on the *SmartSite*, selection guides, videos, and the *Compressed Air & Gas Handbook*.

Visit the CAGI web site at [www.cagi.org](http://www.cagi.org)



“The CAGI BL 5389 Standard provides a simplified wire-to-air performance test code applicable to packaged, low pressure turbocompressors handling atmospheric air.”

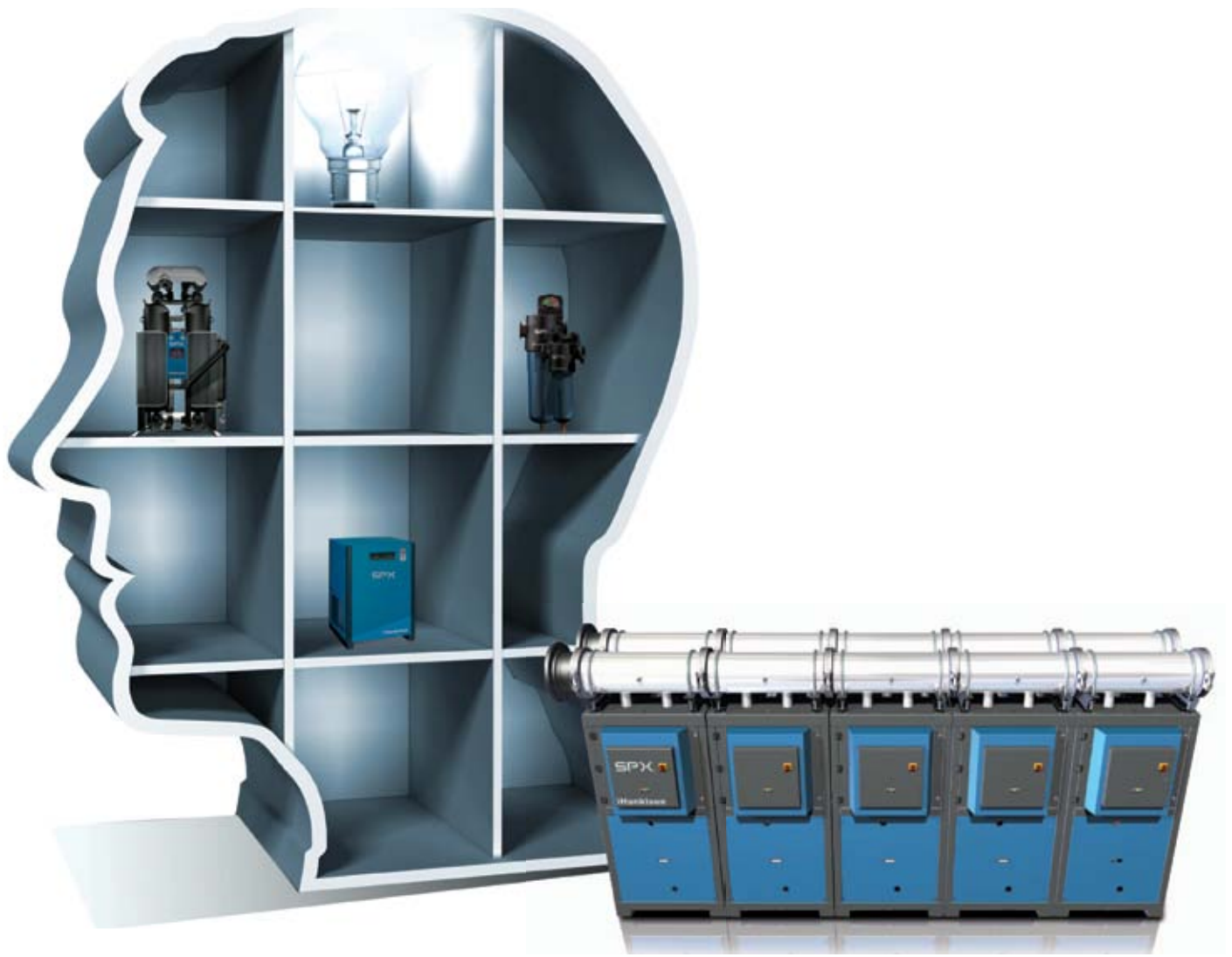

# THINK HANKISON

For Your Energy Saving Solutions

## Where Ideas Meet Industry

Hankison, an SPX Brand, is globally known for compressed air treatment products delivering time proven reliability, premium performance and sustainable energy savings. For over 60 years, we continue to develop innovative technologies to best serve our valued customers.

Choose Hankison...New Products...New Ideas...Still the Best!

Come join us to learn more. Visit us at [www.spx.com](http://www.spx.com).

724.745.1555

 **Hankison**®

# BRINGING THE GLOBAL WATER COMMUNITY TOGETHER



THE LARGEST ANNUAL WATER QUALITY CONFERENCE AND EXHIBITION ON THE PLANET



Covering the full water cycle, WEFTEC is your leading source for research, design, and operation of collection systems, stormwater management, wastewater treatment plants, water reuse and supply, watershed management, and much more.



Through the largest annual water quality exhibition, WEFTEC connects operators, managers, consultants, and buyers with more than 900 leading manufacturers and service providers.



WEFTEC is the greatest opportunity for the international water community by creating business opportunities for individuals and organizations with global perspectives.

## 86th Annual Water Environment Federation Technical Exhibition and Conference

McCormick Place South | Chicago, Illinois USA  
Conference: 5–9 October 2013 | Exhibition: 7–9 October 2013

### SAVE THE DATES

**30 August** Phone, fax, and mail registration deadline

**30 August** Cancellation/substitution deadline

**REGISTRATION IS NOW OPEN**  
[www.weftec.org](http://www.weftec.org)

## COMPRESSED AIR, PNEUMATICS, VACUUM & BLOWER INDUSTRY NEWS

### Kaeser Compressors Wins Award From Xcel Energy

Kaeser has been named an Energy Efficiency Partner of Xcel Energy. This exclusive award is based on number of annual projects, kW/h savings, and rebates paid to mutual customers. By conducting numerous Air Demand Analysis (ADA) system audits in 2012, Kaeser helped customers save 1.1 million kWh.

“Kaeser is known for taking energy efficiency seriously. We are honored to be recognized by Xcel Energy for our efforts,” said Renny Kroge, Manager of Kaeser’s Denver Branch. “We are committed to continue helping Colorado businesses optimize their compressed air systems.”



Visit [www.kaesernews.com/Xcel](http://www.kaesernews.com/Xcel) or [www.kaeser.com/ADA](http://www.kaeser.com/ADA) or call 877-417-3527

### Atlas Copco Named a Leader in the FTSE4Good Index

Atlas Copco Group has been named a “Leader” in the FTSE4Good Index. The company received a score of 96 out of 100 in the global index provider’s evaluation of companies on corporate responsibility issues such as anti-corruption, environmental stewardship and the promotion of labor and human rights. Atlas Copco is one of five companies globally to be named a “Leader” within the Index’s Industrial Goods & Services segment.

The FTSE4Good Index is used by consultants, asset owners, fund managers, investment banks, stock exchanges and brokers as a tool for assessing responsible investments. The Index objectively measures world-leading companies that meet globally recognized corporate responsibility standards in environmental, social and governance practices.



Corporate responsibility is a key element in Atlas Copco's business strategy. It starts with adherence to a comprehensive Business Code of Practice which guides stakeholders through a three-tiered approach to sustainability. This approach emphasizes employee volunteerism through community engagement and partnerships with charitable organizations, while focusing on the integration of sustainable business practices into operations and the design of innovative, energy-efficient products that set new standards in the industry.

"Sustainable productivity lies at the heart of Atlas Copco and we are proud to be recognized as a leader in the FTSE4Good Index," said Jim Levitt, president, Atlas Copco North America. "Our goal is to create value for all of our stakeholders and we work hard to make a positive impact on society and the environment through our products, business practices and charitable projects."

Earlier this year, Atlas Copco was recognized as one of the world's most sustainable companies in the Global 100 list presented at the World Economic Forum and ranked one of the world's most ethical companies

by Ethisphere Institute. Atlas Copco was also included in the Dow Jones Sustainability Index and has been recognized by Forbes, *Thomson-Reuters* and *Newsweek* for its commitment to innovation and sustainability.

Learn more at [www.atlascopco.com](http://www.atlascopco.com)

### FS-Elliott Delivers Compressed Air to the Nation's Most Advanced Turbine Testing Laboratory

FS-Elliott Co., LLC is proud to supply compressed air systems to Penn State University, Pratt & Whitney, and the U.S. Department of Energy — National Energy Technology Laboratory (DOE-NETL) for the recently unveiled Steady Thermal Aero Research Turbine (START) facility. The new facility will run a Polaris<sup>®</sup> air compressor to test a new generation of High Pressure Turbine (HPT) systems in order to improve the fuel efficiency of jet aircraft and land-based power generation turbines.

"FS-Elliott is proud to be working with Penn State, Pratt & Whitney, and the U.S. Department Energy on this ground-breaking project," stated Matthew Vello, Sales Engineer, FS-Elliott Co., LLC. "The Polaris<sup>®</sup>

# HOW DO YOU KNOW?

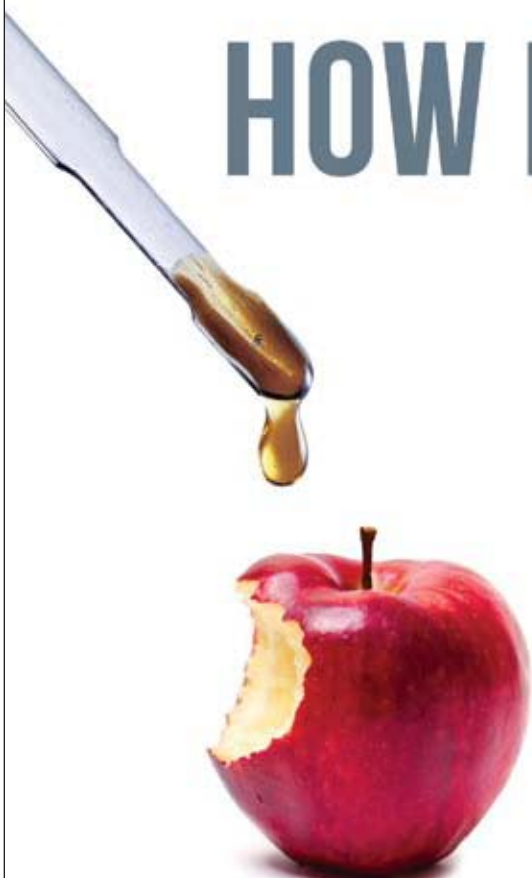

**METPOINT<sup>®</sup> OCV**  
Advanced hydrocarbon monitoring systems for compressed air



**BEKOKAT<sup>®</sup>**  
Advanced hydrocarbon removal systems for compressed air

**EXCLUSIVE TECHNOLOGIES**

Each technology featured above is unique and exclusive to **BEKO** worldwide.



BEKO TECHNOLOGIES CORP | 900 Great Southwest Pkwy SW | Atlanta, GA 30336 USA | +1 (800) 235-6797 | [www.bekousa.com](http://www.bekousa.com)

## COMPRESSED AIR, PNEUMATICS, VACUUM & BLOWER INDUSTRY NEWS

air compressor will provide the high performance and reliability necessary for an application of this nature.”

Due to the complexity of the project, FS-Elliott performed numerous flow and pressure studies in order to analyze the capabilities of the P700 frame. “FS-Elliott was able to work with us by providing performance curves for the 2 stage machine at various off-design conditions, other vendors were not

willing to dedicate their time to this effort,” said Dr. Michael Barringer, Research Associate for the Department of Mechanical and Nuclear Engineering at Penn State University. “The team at FS-Elliott was an invaluable resource to our graduate students as they furthered their research using the data collected during the test stand set-ups.”

In addition to supplying the P700, FS-Elliott distributor, CH Reed, provided the heat exchangers, a chiller, heaters, test piping, valves, a closed loop cooling system and start-up/commissioning of all components for the START facility.

For more information, visit [www.fs-elliott.com](http://www.fs-elliott.com)

### EPA Proposes Rule to Modernize Clean Water Act Reporting

The U.S. Environmental Protection Agency (EPA) has proposed a rule that would modernize Clean Water Act (CWA) reporting processes for hundreds of thousands of municipalities, industries, and other facilities by converting to an electronic data reporting system. The proposed e-reporting rule would make facility-specific information, such as inspection and enforcement history, pollutant monitoring results, and other data required by permits accessible to the public through EPA’s website.

EPA estimates that, once the rule is fully implemented, the 46 states and the Virgin Island Territory that are authorized to administer the National Pollutant Discharge Elimination System (NPDES) program will collectively save approximately \$29 million each year as a result of switching from paper to electronic reporting.

“In addition to dramatically cutting costs for states and other regulatory authorities, the e-reporting rule will substantially expand transparency by making it easier for everyone to quickly access critical

## Monitoring of Compressed Air and Industrial Gases

### Thermal Mass Flow Sensors

- » From ½” (DN15) to 12” (DN300) and up to 580 psi (40 bar)
- » Highly accurate, calibrated at working pressure
- » Interchangeable sensing head
- » Mounting/dismounting without flow interruption

### Dew Point Sensors

- » Down to -76°F (-60°C) dew point
- » Ability to measure flow and dew point at one access point

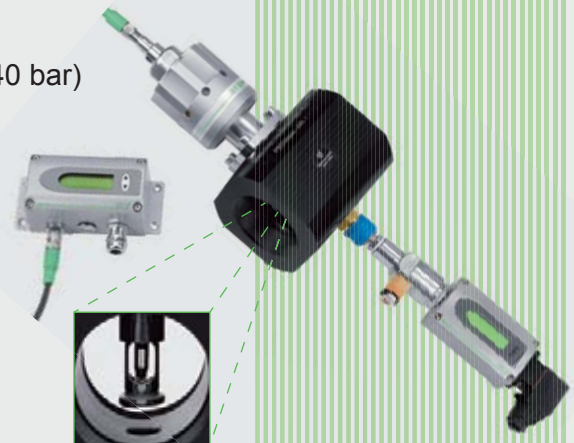

**E+E** YOUR PARTNER IN SENSOR TECHNOLOGY  
**ELEKTRONIK**®

PH: 508-530-3068 • [www.epluse.com](http://www.epluse.com) • [office@epluse.com](mailto:office@epluse.com)

data on pollution that may be affecting communities,” said Cynthia Giles, assistant administrator for EPA’s Office of Enforcement and Compliance Assurance. “The e-reporting rule will also allow states and other regulatory authorities to focus limited resources on the most serious water quality problems, which will lead to increased compliance, improved water quality, and a level playing field for the regulated community.”

Currently, facilities subject to reporting requirements submit data in paper form to states and other regulatory authorities, where the information must be manually entered into data systems. Through the e-reporting rule, these facilities will electronically report their data directly to the appropriate regulatory authority. EPA expects that the e-reporting rule will lead to more comprehensive and complete data on pollution sources, quicker availability of the data for use, and increased accessibility and transparency of the data to the public. The CWA requires that municipal, industrial or commercial facilities that discharge wastewater directly into waters of the United States obtain a permit. The NPDES program requires that permitted

facilities monitor and report data on pollutant discharges and take other actions to ensure discharges do not affect human health or the environment. Most facilities subject to reporting requirements will be required to start submitting data electronically one year following the effective date of the final rule. Facilities with limited access to the Internet will have the option of one additional year to come into compliance with the new rule. The proposed rule will be available for review and public comment for 90 days following the publication date in the Federal Register.

View the proposed rule in the Federal Register: <https://www.federalregister.gov/articles/2013/07/30/2013-17551/npdes-electronic-reporting-rule>

More information on webinars: <http://www2.epa.gov/compliance/proposed-mpdes-electronic-reporting-rule>

To read more **Industry News** articles, visit [www.airbestpractices.com](http://www.airbestpractices.com)

**COMPRESSED AIR *ALSO* PRODUCES OILY CONDENSATE\***

**Help ensure it doesn't impact our ENVIRONMENT.**



**JORC Zero Air-Loss Condensate Drains and Oil/Water Separators provide SUSTAINABLE CONDENSATE MANAGEMENT**

Sepremium Oil/Water Separator

*\*A 250 hp compressor can produce 40,515 gallons of oily condensate per year.*

**Zero Air-Loss Condensate Drains**

Electronic



Smart Guard Ultra



Smart Guard

No Electricity Required



Mag-11 - 230 psi



POD-DC Non-Electric

**Lock-Down Air Leaks**



Air-Saver G2



JORC Industrial LLC • 1146 River Road • New Castle, DE 19720  
Phone: 302-395-0310 • Fax: 302-395-0312 • info@jorc.com • www.jorc.com

# Q&A: Black & Veatch on the ASME PTC-13 Blower Standard

By Rod Smith, Compressed Air Best Practices® Magazine

► Compressed Air Best Practices® Magazine interviewed Ms. Julie Gass P.E., Lead Process Mechanical Engineer from Black & Veatch, on the new ASME PTC-13 Standard. Ms. Gass is a member of the ASME PTC-13 Working Committee.

## Good morning. Why the need for a new standard for wastewater treatment plants?

Good morning. As we reviewed last year, aeration blowers consume 40 to 70 percent of the over-all energy consumption at a wastewater treatment plant (WWTP). For those of us designing or retrofitting WWTP aeration

blower systems, we are faced with a major design challenge. We must design aeration blower systems that will meet peak load requirements that occur perhaps one day a year- yet operate efficiently the rest of the year under ever-changing partial-load conditions.

Aeration blower system designers must always answer the question, “What will the energy consumption be from our blower system under a range of partial-load working conditions?” While we rely on blower manufacturers to provide us this data, we check their data and need to have a way to verify their power guarantees after the blowers are built to the requirements of our specification.



Julie Gass P.E., Lead Process Mechanical Engineer, Black & Veatch.



ASME initiated PTC-13 at the request of the Consortium for Energy Efficiency (CEE). The CEE is a consortium of utility efficiency program administrators from across the U.S. and Canada. Several years ago, there was a renewed interest in developing incentive programs for wastewater treatment plants to encourage them to reduce the energy costs of their systems. CEE quickly became aware of the new blower technologies being introduced to the market and realized there was no test standard available to verify the performance of the new blower technologies. Engineering companies and equipment manufacturers were also aware of this problem. All parties began looking for a solution and two committees were formed to author new test codes.

By providing more accurate and reliable energy performance numbers, Contractors and WWTP plant operators will be better able to consider the lifecycle cost of the aeration blower systems and verify whether blowers are performing as advertised.

### What kind of ASME Standard was the CEE asking for that didn't already exist?

The CEE was looking to ASME to create an energy performance test methodology for a packaged blower system in a WWTP. The existing ASME Standard, ASME PTC-10 (for centrifugal blowers), focuses on the bare blower unit itself and does not help system designers determine the power consumption of the entire aeration blower system or package. While ASME PTC-10 can be used for higher pressure compressors and gases other than air, this may unnecessarily complicate the analysis of air blowers used in the wastewater industry. Wastewater aeration blowers come in so many different package configurations and often have many energy consumers in addition to the blower itself which need to be accounted for.

When Black & Veatch designs a variable speed aeration blower system, for example, we typically require harmonic filters. This is because many blowers have high-speed drives and motors which could result in potentially damaging electrical harmonics. The harmonic filter is just one small example of a component that needs to be included in the total power consumption of the blower package. We want to know the energy consumption of all other ancillary equipment in the aeration blower system, as well.

### Please provide a brief overview of ASME PTC-13 and it's status.

Our goal is to have the ASME PTC-13 Draft ready for peer review for the 2013 WEFTEC Show (held October 5-9 in Chicago). We then would hope to have the final version published several months later.

# A New Twist in Energy-Efficient Air

Learn how to save energy and increase operating efficiencies with the Aerzen Delta Hybrid Rotary Lobe Compressor.



- Substantial energy savings
- Reliable and durable
- Space saving, easy handling
- Reduction of maintenance costs
- Simple operation up to +22psig / -21" Hg

## Delta Hybrid



**AERZEN**  
One step ahead.

To learn more, visit [www.aerzenusa.com](http://www.aerzenusa.com)

108 Independence Way • Coatesville, PA 19320  
(610) 380-0244 • [inquiries@aerzenusa.com](mailto:inquiries@aerzenusa.com)



**Your Partner in  
Air Compressor  
Custom Cooling  
Systems**

For more information  
contact us at:

[www.hydrothrift.com](http://www.hydrothrift.com)

**330-837-5141**

## Q&A: BLACK & VEATCH ON THE ASME PTC-13 BLOWER STANDARD

ASME PTC-13 applies to all blower technologies providing air at discharge pressures up to 45 psig. It may be used for gearless turbo, dry screw, positive displacement, single stage centrifugal, multistage centrifugal, or any other type of air blower. The new ASME PTC-13 Standard provides an energy test methodology for the entire blower package system. The outcome of these tests will be to provide customers and design engineers “Wire-to-Air Blower System Power” numbers — under a wide range of ambient and operating conditions.

Energy performance testing will be done at the manufacturer’s facility. Manufacturers should be preparing their test labs now to comply with the new standard. The manufacturers typically have the calibrated instruments and test piping needed for accurate tests. The Engineer’s specification will typically specify several operating points at which energy consumption must be measured during the test.

Specified ancillary equipment will be tested or otherwise accounted for, for energy consumption, with the package. Estimates can be made of the power consumption of some ancillary products if it is agreed to by all parties. The tests are frequently witnessed by an engineer from the consulting firm, and also by the end user if required.

The Standard also provides tables that list out all the possible components to either include in the performance test or to adjust results by calculation. A list of some of the components we are covering is below.

- Inlet isolation valve
- Throttling valve
- Enclosure doors
- Inlet silencer
- Drive motor
- Motor cooling fans

- Magnetic air bearing and controller
- Bearing cooling fan
- Coolant pump
- Lubrication pumps and accessories
- Heat exchanger fans
- VFD
- VFD line-side power conditioning equipment
- VFD load side power conditioning equipment
- Control panel
- Power isolation transformers
- VFD water conditioning or chilling

### How will PTC-13 affect energy consumption estimates?

ASME PTC-13 will provide an accurate method of testing blower packages to verify power consumption. Specifications sometimes include a penalty clause. If a power requirement is not met, as evidenced by the PTC-13 test results, the manufacturer would often be given the opportunity to modify the machine and then do a re-test. If the situation is not resolved and if a penalty is part of the contract, the blower manufacturer would have to financially compensate the Owner. The amount of the penalty is frequently based on the extra energy costs borne by the customer, over a period of years. We expect this will result in more accurate and, in some cases, more conservative energy consumption estimates being made by the manufacturers when the machines are being selected and specified.

### You mentioned there will be a workshop on ASME PTC-13 at WEFTEC?

Yes. Our ASME PTC-13 Committee will do a one-day workshop at WEFTEC on October 5

in Chicago, titled, “No Nonsense Data: Wire-to-Air Blower Power.” The goal of the workshop is to provide hands-on opportunities for the participants with calculation examples. The Workshop is sponsored by ASME, the Municipal WWTP Design Committee, the Manufacturers and Representatives Committee, and by the Sustainability Sub-Committee. It’s a day-long workshop with Tom Jenkins (JenTech) as the Workshop Chair and Hiran deMel (CH2M HILL) as the Workshop Vice Chair. Some of the presentations are:

- Jack Karian — ASME: “History of PTC-13”
- Jacque Shultz — Siemens Energy, Inc.: Overview of PTC-13
- Julie Gass — Black & Veatch: “Code Applications in Design”
- Ralf Weiser — Aerzen USA: “Positive Displacement Blower Fundamentals and Test Procedures”
- Lloyd Slezak — Brown and Caldwell: “Dynamic Blower Fundamentals and Test Procedures”
- Hiran deMel — CH2M HILL: “Code Applications in Construction and Field Considerations”

**Thank you and we look forward to seeing you at WEFTEC. **

For more information visit Black & Veatch at [www.bv.com](http://www.bv.com) or contact Rod Smith at Compressed Air Best Practices® Magazine, email: [rod@airbestpractices.com](mailto:rod@airbestpractices.com), [www.airbestpractices.com](http://www.airbestpractices.com)

To read more **Wastewater Treatment** articles, visit [www.airbestpractices.com/industries/wastewater](http://www.airbestpractices.com/industries/wastewater)



**“True greatness comes from within: This is where oil free compressed air is generated with low energy consumption.”**

*Thomas Lalk, Product Developer Oil free Screw Compressors, BOGE*

Aside from reliably and efficiently generating high quality oil free compressed air, our SO 270 has more to offer than meets the eye: e.g., for further efficiency improvement, the option to use an external HOC adsorption dryer which uses the existing heat of the compressed air to dry it entirely without any additional energy supply. Another option is heat recovery. Highest energy efficiency for extreme applications – the water cooled SO 270, with or without frequency control, is ready to provide your company with the necessary **air to work**.

 **BOGE**  
COMPRESSED AIR SYSTEMS

**BOGE AIR. THE AIR TO WORK.**

To learn more about BOGE, the SO product range, or our other products phone **770-874-1570** or visit [www.boge.com/us](http://www.boge.com/us)

# EVALUATING DIFFERENT BLOWER TECHNOLOGIES ON A WIRE-TO-AIR BASIS

By Andrew Balberg, Business Development Manager—Low Pressure, Atlas Copco

## ► The Problem

In the absence of official third party specifications on energy efficiency, it is difficult to evaluate and compare blower technologies fairly and effectively. The lack of readily available evaluation tools leads to misinformation and unfair comparisons between technologies. Further, the performance verification process is difficult to prove.

## The Objective

Blower manufacturers and their related industries are researching ways to develop fair evaluation criteria and specifications that can be used to determine which blower technology offers the best energy efficiency and performance for a particular application. The evaluation would measure the total energy consumption used by the entire blower system



Atlas Copco ZS Screw with VFD Blower Package

in real world conditions, while taking into account all potential energy losses.

## Identifying the Problem

Five basic blower technologies serve the water and wastewater markets: Positive Displacement Lobe Type, High Speed Screw, Multistage Centrifugal, Integrally Geared Single Stage and Gearless Single Stage “Turbo” Technologies that incorporate air or magnetic bearings. Each have all the same basic components, a compressor, motor, starter and inlet filter, and some technologies also have cooling systems, an oil pump, gears, belts, couplings and control systems. Whether the components are shipped separately and assembled on location or pre-assembled with a controller, variable frequency drive and sound enclosure, the



Atlas Copco ZM Multistage Centrifugal Blower Package

evaluation should include all relevant pieces that consume or affect performance.

Each of the five different technologies offers a potential solution to water and wastewater aeration applications; however, common evaluation criteria are necessary to offer a fair comparison. Unfortunately, there is no rule of thumb that would reveal one technology as better than the other when considering a 20-year life cycle cost (with power representing at least 75 percent of the total cost analysis) that includes power consumption, capital costs, ongoing maintenance and repairs. Because blowers consume 50 percent of the total power consumed by a typical wastewater plant, energy efficiency is a primary criterion when selecting new technology, but not the sole criterion.

## Wire-to-Air Principal

The term “wire-to-air” describes the total energy needed to produce the required flow and pressure for any particular application. The relationship between total input power

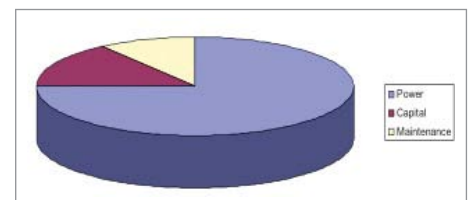

20 year Life Cycle Cost



and the amount of flow and pressure produced is replacing a straight efficiency percentage as a comparison criterion. Efficiency as a percentage can be defined as isentropic or polytropic, along with many other definitions; however, defining efficiency this way does not necessarily correlate to useful energy. For instance, higher discharge heat can increase efficiency as a percentage, but higher discharge heat is not a useful state of energy for the process and therefore is a misleading indicator of true energy usage. Rather, the factors that matter the most for biological processes are input power and pounds of oxygen on the discharge (mass flow rate).

With the introduction of high speed “Turbo” and other prepackaged blowers, where the motor and compressor are combined into one unit that comes in a prepackaged system with drive, controller and cooler, the only way to evaluate the technology’s efficiency is through a wire-to-air approach. Traditionally, evaluations have only taken into account the shaft brake horsepower, which is the power to rotate the compressor, excluding the motor and all other drive losses. But to make an equal comparison between technologies, the drive losses of the complete system that includes the motor, starter, variable frequency drive, inlet filters, gears, belts, guide vanes, valves and cooling system need to be measured.

The average user will not fully understand all the different technologies available when it comes to their inner-workings and design, so a wire-to-air specification will require that the entire blower system be fully assembled for testing. The use of nominal or nameplate efficiencies of the various components will not be allowed. The wire-to-air specification puts the responsibility on the manufacturer to design and build a complete blower system where all losses have been

accounted for due to real life testing within the application.

Instead of relying on just one particular flow and pressure to compare energy usage, dynamic performance should also be noted when measuring the evaluated power usage over a range of operations. See the table for an example of a simple evaluation that lists four performance points and gives each a weighted average for real process conditions. The basic premise is to evaluate how the blower will work across the entire range of its expected operation. The variable flow or pressure and the power that different blower technologies consume over a range of performances will also have a large impact. Also note that air densities are accounted for, given that temperature, humidity and elevation all impact performance.

The definition of wire-to-air will include all the actual components required and supplied on the particular application and will be tested as a working system over a range of operating points. Verification will involve measuring kilowatts (kW) at the system’s entrance and measuring mass flow rate at the system’s discharge. These two points can be independently verified by using a three phase kW meter that measures power from the wall and a fixed orifice plate flow meter where the delta pressure and temperature can be measured on either side to determine the mass flow rate produced. To produce the exact design points of flow and pressure during the verification testing, the blower system can be regulated by its own control system. Then, the corresponding kW reading can be recorded to prove any guaranteed kW points offered by

## COMPRESSED AIR IS ENERGY

### Don’t let it go to waste

Our low-cost, easily-installed flowmeters are changing the way people manage their compressed air systems. Metering branch lines reveals dramatic savings opportunities and ensures that once savings are achieved, they are maintained.



### cdimeters

[www.cdimeters.com](http://www.cdimeters.com)

Phone: 781-935-9600 • Toll free (US and Canada): 866-885-2462

## EVALUATING DIFFERENT BLOWER TECHNOLOGIES ON A WIRE-TO-AIR BASIS

| DESIGN POINT | USE FACTOR | CAPACITY | PSIA | FLOW IN SCFM | TEMPERATURE | RELATIVE HUMIDITY | PSIG DISCHARGE | GUARANTEED KW OF BLOWER | WEIGHTED KW |
|--------------|------------|----------|------|--------------|-------------|-------------------|----------------|-------------------------|-------------|
| 1            | 25%        | 100      | 14.7 | 6650         | 89          | 48%               | 8.40           | 210                     | 53.75       |
| 2            | 30%        | 90       | 14.7 | 5985         | 83          | 54%               | 8.40           | 186                     | 56.7        |
| 3            | 25%        | 80       | 14.7 | 5320         | 70          | 50%               | 8.40           | 168                     | 42.5        |
| 4            | 20%        | 50       | 14.7 | 3325         | 20          | 39%               | 8.40           | 107                     | 23          |
|              |            |          |      |              |             |                   |                | Weighted Average KW     | 175.95      |

the manufacturer. Such a test can only be done in a qualified testing facility under controlled conditions and not in the field.

### Existing Testing Codes

Performance test codes in use today are not suited for a wire-to-air scenario across all technologies. Current test codes do not address power measurement adequately; nor do they define the scope of supply components or address specifically where to measure mass flow.

**ASME PTC-10** is a commonly prescribed test code for centrifugal blowers. This code only covers the power that is based on the shaft power to the element and does not cover losses across the motor or any other part of the blower system. The code allows for many deviations and does not indicate which processes should be used to measure flow as it allows inlet or discharge flow measurements. The translation from test conditions to site conditions is also not very clear and subject to interpretation. Translations from test

conditions to site conditions are not linear and assuming that they are linear results in an inaccurate representation of the actual performance of the blower. These allowable deviances have been used to overstate a blower's true performance by as much as 10%.

While a common practice today, using nameplate efficiency data on motors, valves or other accessories reveals loose data sets that vary greatly between manufacturers. These efficiency changes are based on loading; therefore, the deviance is exacerbated the further you are from nameplate. Even a 1% efficiency loss can equal be larger than the cost of the product over 20 years.

**ASME PTC-9** is a now an inactive specification originally written for positive displacement blowers in much the same way as PTC-10 does for shaft power. This specification is obsolete and no longer active.

**ISO 1217** is an active specification covering positive displacement blowers and was originally written for shaft power like the other

specifications. This specification has been amended to include a wire-to-air annex as listed below.

### The Solution

A test code should take into account the entire blower system to make sure every item is maximized to its energy use. This would give a much more realistic estimate of how much power savings will occur in an application with variable loads that simulate the field.

### ASME PTC-13

The industry is already aware of the need for a new power evaluation and there are several efforts underway to present a wire-to-air specification to meet this need. The American Society of Mechanical Engineers (ASME) formed a new committee in 2008 to write a completely new power test code for low pressure compressors. The committee largely consists of environmental consultants, manufacturers and end customers. ASME PTC-13 encompasses a strict procedure that can be



Atlas Copco ZB Air Bearing Turbo Blower Element



Atlas Copco ZB Integrally Geared Turbo Blower Package



Atlas Copco ZB Magnetic Bearing Turbo Blower Package

used for “all” blower technologies on a simple wire-to-air principle. The procedure would test the entire blower system including motor, drive, gears, belts, filters, cooling systems, etc. and measure the flow and pressure on the discharge of the system proposed. This is a lengthy and detailed test procedure that can be used to verify the actual performance of the equipment before it is shipped to the field.

*There will be a day-long session available at WEFTEC 2013 conference in Chicago concerning the outline of ASME PTC-13 Code. This code is scheduled for release by ASME in early 2014 for general use.*

#### ISO 1217 Annex C

The ISO 1217 specification and subsequent Annex C revision is currently a published specification and can be used today. It was written for positive displacement lobe type blowers. This specification encourages routine tests that report base performance on a wire-to-air format of positive displacement blower packages. This specification is currently published and available for use when considering positive displacement type blowers.

#### ISO 5389 Annex G

The ISO 5389 specification is similar to PTC-10 because it covers centrifugal type blowers on a shaft break horsepower only; however, there is an effort underway to add a wire-to-

air Annex G section to encourage a wire-to-air evaluation. This specification is not currently available as a published specification by ISO, but will be in a draft form this year with an official publication date several years later. Annex G can also be used like the predecessor ISO 1217 Annex C as a routine test when it becomes available.

#### Conclusion

Power consumption, while important, is just one criterion in the selection of blower technology. Other factors such as noise levels, environmental impact, access to service, or even the performance characteristic of the application itself should be evaluated when selecting a blower technology. When comparing power usage, a wire-to-air approach, backed by a published standard, is the only fair and unbiased way to evaluate between technologies. Beyond evaluation, the manufacturer should have the facilities to perform testing in accordance with the specified code. Please consider this approach in your next blower application. **BP**

*For more information please contact Andrew Balberg, Business Development Manager — Low Pressure, Atlas Copco, email: [andrew.balberg@us.atlascopco.com](mailto:andrew.balberg@us.atlascopco.com) or visit [www.encyclopedia.com](http://www.encyclopedia.com)*

To read more **Blower Technology** articles, visit [www.airbestpractices.com/technology/blowers](http://www.airbestpractices.com/technology/blowers)

Houston Service Industries (HSI) — a world leading manufacturer of centrifugal blowers, exhausters and control systems — was acquired by the Atlas Copco Group in January 2012. This acquisition combines the best of both companies’ technologies to provide the most complete range of air and gas blower solutions to the wastewater industry. HSI products, including multistage centrifugal blowers and high speed turbo blowers, are now part of a complete product portfolio that complements the Atlas Copco range of ZS screw blowers and ZB centrifugal blowers.

**Atlas Copco**



**Everything  
Running Smoothly,  
Every Day**  
(after day, after day)

Our R-Series Rotary Screw Compressors prove that R stands for rugged reliability. Designed for virtual 24/7 operation, the R-Series line offers advanced features like Progressive Adaptive Control™ (PAC™) protection, V-Shield™ technology, a sequential cooling system and state-of-the-art Xe-Series controls for efficient operation and reduced cost of ownership.

Innovative designs backed by a century of service. Dependability for decades. That’s

*Ingersoll Rand.*

[www.ingersollrandproducts.com](http://www.ingersollrandproducts.com)

**IR** Ingersoll Rand

# Advanced Automation Lowers Labor Cost and Improves Performance at the Las Palmas, California Wastewater Treatment Plant

By Nate Ventress, Process Automation Specialist, Western Region, Festo

► The Salinas Valley of California, southeast of San Francisco, is referred to as the “salad bowl of the world” because of its abundance of such crops as lettuce, broccoli, and peppers. And like many agricultural areas in California, the water supply is under stress from high usage, rising population, and changing weather patterns. Therefore, every water conservation effort in the valley contributes to the overall health of the vitally important agriculture industry.

Recently the capacity of the Las Palmas, California, waste water treatment operations were expanded by combining two plants and

making one centralized filtration center. The new center expanded the flow capacity from 162,000 Gallons per Day (GPD) combined to 288,000 GPD when the manually controlled reclaimed water operations were updated to a state-of-the-art automated system.

Reclaimed water from the plant irrigates local community green spaces. The new automated system ensures lower labor costs, consistent quality, and peak efficiency in the process of reclaiming waste water for irrigation. And through this water conservation process the Las Palmas facility contributes to the overall sustainability of Salinas Valley agriculture through water reuse.

To facilitate an effective transition from last generation to next generation technology, a turnkey/scalable system was sourced from Festo, under the direction of general contractor ERS Industrial Services, Fremont, California.

## Plant #1 Operated at Lower Capacity Than Required by Today's Demands

Plant #1, with its capacity of 72,000 GPD, was built in 1989 in Salinas to reclaim water from the nearby Las Palmas Ranch residential development. In 1996, Plant #2 with a capacity of 90,000 GPD was built to accommodate soaring population growth. That growth



“One of the process innovations we thought offered the highest value was to find an automation supplier with the experience and expertise to design and deliver a complete turnkey control solution.”

— Nik Radonich, Project Engineer, ERS

continued and by 2009 additional capacity was needed. Plant #1 could accommodate higher GPD with an upgrade in technology, so ERS, with deep roots in the water filtration and treatment community, was hired as the general contractor on the expansion project.

### Expanding Capacity on the Same Site Made Sound Economic and Operational Sense

“Our goal from the beginning was to keep costs low and system performance high through technology innovation,” said Nik Radonich, project engineer, ERS. “One of the process innovations we thought offered the highest value was to find an automation supplier with the experience and expertise to design and deliver a complete turnkey control solution. We believed that one point of contact would speed communication and assign responsibility. We wanted one source thoroughly knowledgeable about the system to document, train, and provide support services. Finally, we were looking for automation system interoperability, where the majority of components were designed to integrate with one another.



Figure 1. Close up of Festo Process valve, actuator, and limit switch assembly.

“After evaluating and rejecting a number of automation companies that could supply a partial, but not complete solution, ERS selected Festo Corporation, Hauppauge, NY. Festo met all of our criteria and has an extensive track record of successfully completed projects in the global water/waste water industry in Europe, the Middle East, and the Americas.”

### An Overview of the Automation Solution

One of the first things ERS did was to repurpose two treatment vessels no longer in service. These 5 foot diameter by 15 feet long horizontal vessels replaced four 5 foot diameter by 7 feet long vertical vessels. The horizontal vessels ensured more efficient/higher capacity operation.



Figure 2. Top, left to right backwash supply valve, effluent discharge valve, and backwash discharge valve.

In the waste water reclaiming process, water is forced, under pressure, through a filter medium bed to remove the remaining suspended solids from earlier treatment before disinfection and final discharge. The filter bed is made of crushed anthracite (hard coal)

An advertisement for Anest Iwata. The background is green with a white and blue scroll compressor unit. The text reads: "ANEST IWATA Oil Free Scroll! Silent / Clean TECHNOLOGY". At the bottom, it says "Interested in Becoming a Distributor?" and provides contact information: "toll free: 800-440-0282 www.anestiwata.com".

## ADVANCED AUTOMATION LOWERS LABOR COST AND IMPROVES PERFORMANCE

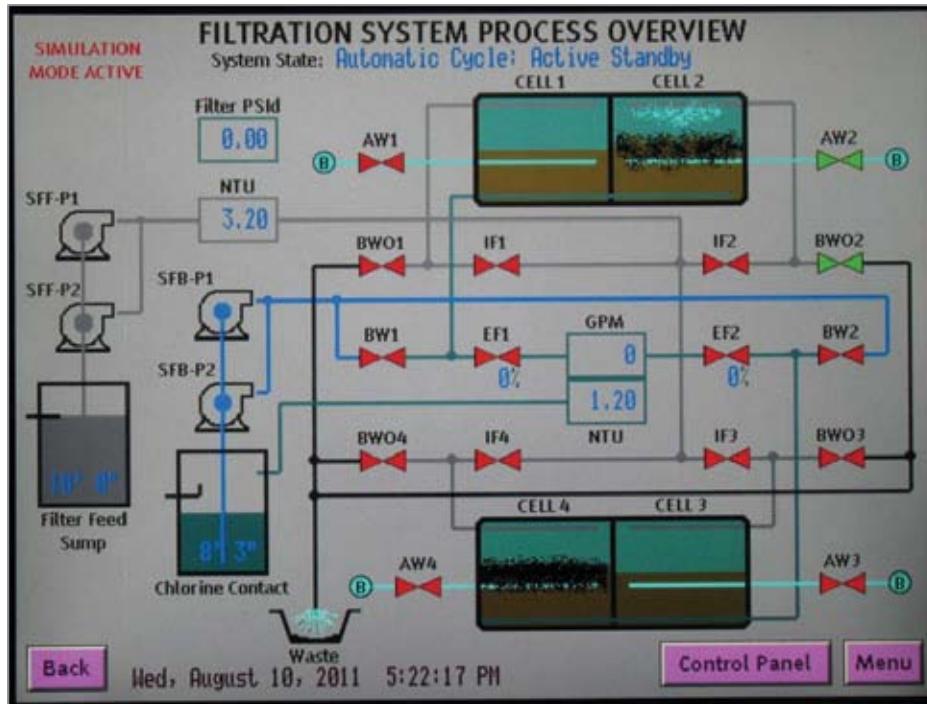

Figure 3. HMI Screen — System Process Overview

over crushed gravel. Each tank is separated into two compartments, for a total of four individual cells.

The two cells in each tank share a common collector pipe, backwash supply valve, and effluent discharge valve. There are a total of 14 such assemblies, in different sizes, for managing the flow of water and air through the filter cells. The valve shown in Figure 1: is used to introduce air into the tank for pre-backwash agitation of filter media (air-scouring). By utilizing the air scour system the wash time was reduced 30%.

Figure 2: offers a close up of three different AWWA valve assemblies. All process valves, actuators, and limit switch assemblies were supplied by Festo.

The effluent discharge valve operates proportionally with the help of a pneumatic proportional positioning valve and position feedback unit. This system allows the operators to set the desired flow rate. A magnetic flow meter provides feedback to the PLC, which uses a PID flow control loop to modulate this valve. There are two such valves in this system. Festo pre-assembled all process valve assemblies prior to shipment to Las Palmas.

### The Whole System Graphically Presented on the Operator Screen

The Process Overview screen is the main control point for the filtration system. The overview screen provides a complete view of the entire process as a graphical representation with real-time instrument data, graphical animations, and touch-sensitive areas that are used for showing an item in more detail. For example, touching any of the valve, filter, or pump symbols changes the displayed page to one dedicated to the device.



Figure 4. Plant Overview. Control Panel, Process Valve Assy. & Filter Cells.

This screen also shows the states of the various analog instruments that are used in this system:

- Tank level sensors, showing level in feet and inches
- Turbidity sensors, showing the amount of suspended solids in the influent and effluent streams in Nephelometric Turbidity Units (NTU)
- Differential pressure between the filters intake and discharge manifolds, which indicates the backpressure across the active filter bed used for determining if a filter needs to be cleaned
- Flow Meter showing the flow in gallons per minute leaving the system

The 120VAC power supply and I/O connections to remote instrumentation and the pump control center are housed in an adjacent building. Tying this system into existing plant equipment required the close coordination of ERS, Festo, plant personnel, and electricians working on site.

The Festo CPX valve terminal assembly provides extensive self-diagnostics. Self-diagnostics ensures that hardware problems can be quickly identified with pinpoint accuracy. Screen icons provide a graphical representation of all modules in the CPX assembly. Trouble on any module is indicated by a red warning symbol. Touching the icon reveals more detail about the problem. Process data is also collected and saved for analysis.

Festo designed this system to be scalable, which means that the same fundamental system can be designed, pre-wired, and assembled for different sized projects more quickly and with more assurance of success than building

from scratch. Furthermore, since the majority of components were designed to work with one another, operators are assured of peak interoperability.

Operators report that the system performs to expectation and the information available from the control screens helps to ensure peak efficiency and faster problem resolutions with added diagnostic and test screens.

### Key Technical Details of the Automated System Include:

#### Control Hardware:

- Closed loop — real-time visualization of the entire filtration process
- HMI with Interactive animated graphics and alarms

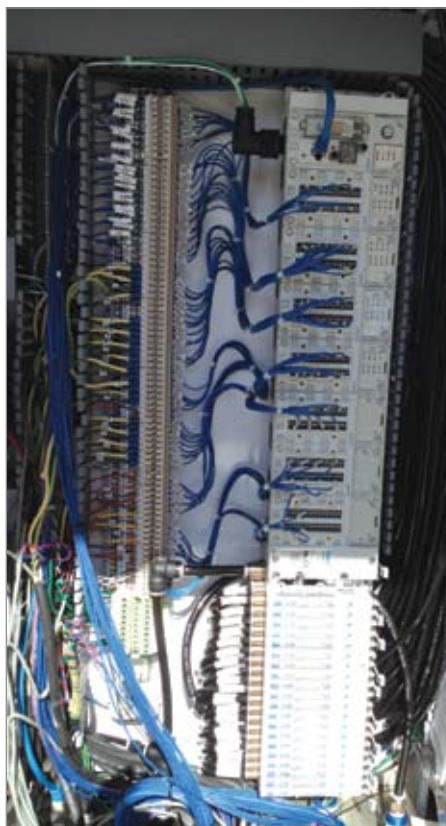

*Festo's CPX/MPA Control Platform Inside the Control Panel*

## FESTO



### Improve Process Reliability!

The right compressed air preparation system significantly increases the service life of components and systems – as well as the process and product reliability.

For more information:

Call: **1-800-Go-Festo**  
**1-800-463-3786**

[www.festo.com/us/airquality](http://www.festo.com/us/airquality)

Global manufacturer of process control and factory automation solutions



## ADVANCED AUTOMATION LOWERS LABOR COST AND IMPROVES PERFORMANCE

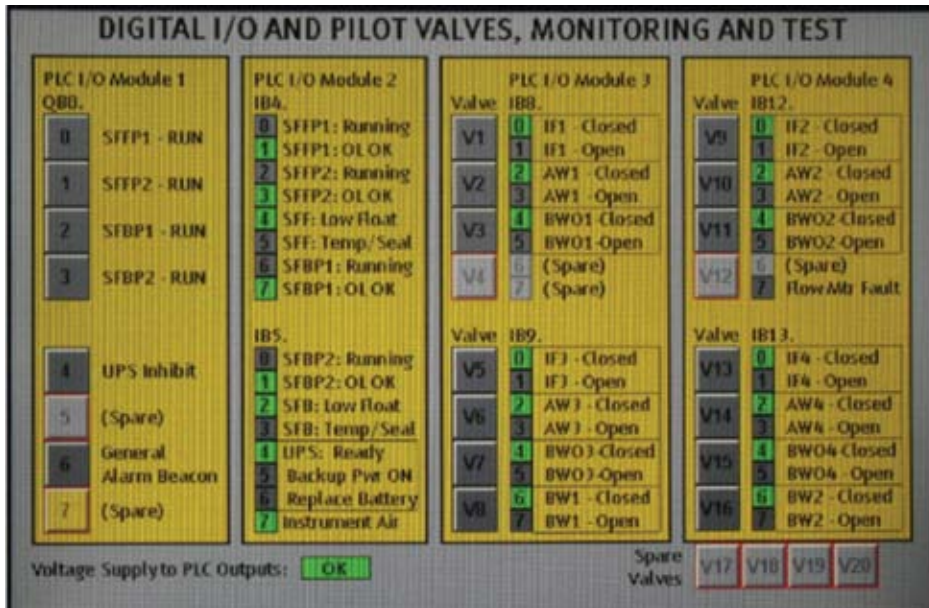

Figure 5. HMI Screen — Diagnostics Monitor & Test

- Festo's CPX/MPA product that allows PLC, I/O, and Pneumatic valve integration
- Ethernet communication for simple programming, module library included.
- PLC and HMI Application Software with open protocol CoDeSys IEC 61131-3
- On board diagnostics with I/O and solenoid valves saves operators trouble shooting commissioning time
- Bi-stable AWWA Process Valve, Pneumatic Actuator, and sensor box (Festo), 14 sets. Bi-stable Ball Valve Assy. (Festo), 4 sets

## You Compress Air. We Make Sure It's Dry.

Optimize your compressed air quality with the right dew point instrument.

- ✓ Fastest wet-to-dry response time on the market - just minutes
- ✓ Minimal drift and long 2-year calibration interval
- ✓ Product range from -80°C to +60°C Td with ±2 accuracy
- ✓ High resistance to contamination - immune to compressor oil
- ✓ Complete recovery from saturated conditions

Visit [www.vaisala.com/compressedair](http://www.vaisala.com/compressedair) for more information plus Application Notes, White Papers and more...

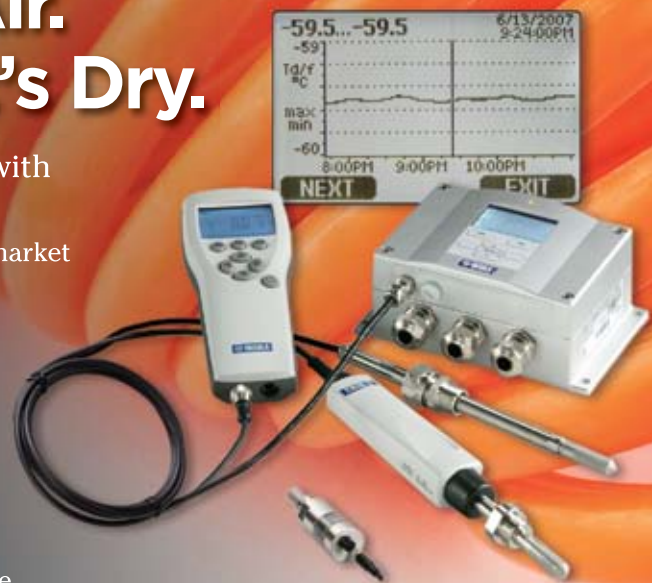

[www.vaisala.com/compressedair](http://www.vaisala.com/compressedair)

**VAISALA**





Festo process valve, actuator, and limit switch assembly.

- Proportional AWWA Process Valve, Pneumatic Actuator (Festo), Electro pneumatic proportional positioner, 2 sets
- 4-20 mA Proportional valve position set point receivers & feedback transmitters, 2
- 8 Digital Output Points
- 48 Digital Input Points
- 8 Analog Inputs
- 2 Analog Outputs
- 20 MPA Size 1 pneumatic valves
- Uninterruptible Power Supply, 5 hour hold-up time
- Complete Control and Setup Point
- UL508A Stainless steel enclosure, designed for outdoor operation
- Influent Holding Tank, 5000 Gallon
- Effluent receiving and disinfection tank, 7000 Gallon
- Redundant double centrifugal pump set, 2 Sets (Alternating control via PLC)
- Air Blower
- Process Instruments
  - Magnetic Flow Sensor, 1
  - Ultrasonic Tank Level Sensors, 2
  - Turbidity meters (for suspended solid particle measurement), 2
  - Differential Pressure Sensor, 1 **BP**

For more information visit [www.festo.com/us](http://www.festo.com/us)

**Plant Hardware:**

- Pressure Filter Cells, Anthracite/sand media, 4 (two per tank)

To read more [Pneumatic Technology](#) articles, visit [www.airbestpractices.com/technology/pneumatics](http://www.airbestpractices.com/technology/pneumatics)

# Sullivan Palatek

## INDUSTRIAL AIR COMPRESSOR 15-40 HP



**FEATURES:**

**Electric Motor 208, 230, 460, 575 Volts**

**Motor Starter - 208/230/460/575 Volt (15-25 HP) 460/575 Volt (30-40 HP)**

**Protective Devices**

**Oil Level Sight Glass**

**ASME Coded 200 PSI**

**Separator/Sump Tank**

**Direct Drive Coupling**

**Quality Instrumentation**

**All new Platinum and Platinum-Plus Warranties available.**

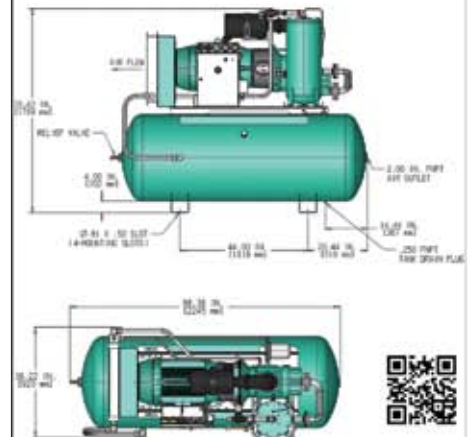

**Sullivan-Palatek**  
1201 W US Hwy 20  
Michigan City, IN 46360  
219-874-2497  
Fax: 219-872-5043  
[www.sullivanpalatek.com](http://www.sullivanpalatek.com)

# Magnetic Bearings: An Attractive Force for Energy-efficiency



*An Aeration Blower Permanent Magnet Motor*

**By Mark Hinckley, Director  
Strategic Projects, SKF  
Strategic Industries**

► **With sustainability and energy-efficiency targets tougher than ever, magnetic bearings are drawing the attention of engineers in many industries, offering a whole range of advantages from increased performance to extended lifespan.**

In the industrial world today, priorities are changing. Increasingly, environmental impact and the cost of energy are influencing our priorities and the decisions we make. In addition, productivity, efficiency, minimizing variance, extending warranties and managing the total cost of ownership are driving consumers' choices.

Our world and our livelihoods are increasingly tied to global conditions. Both financially and environmentally there are increasing benefits to be achieved by improving the

efficiency and consistency with which we utilize our natural resources. SKF through its BeyondZero™ initiative aims to increase the positive environmental impact of its solutions by offering new technologies, products and services with enhanced environmental characteristics. Customers want to ensure that they are buying products and equipment that are not only robust and reliable but innovative and sustainable. We are moving towards a more responsible industry, where products that can address all these needs are valued more highly than ever before.

With world water consumption expected to rise around 50% by 2020\*, biological wastewater plants are looking for more effective, energy-efficient water treatment technologies. Aeration blower systems present a prime opportunity for asset improvement.

(\*Source: [www.theworldwater.org](http://www.theworldwater.org))

## **Magnetic Bearings for Aeration Blower Systems**

In traditional wastewater facilities, the aeration blower system can represent over 40% of the plant's total energy use. Used to blow air into tanks so bacteria can break down organic waste, a typical mid-size aeration system operates with two to five air blowers. For each blower, energy use accounts for up to 80% of its total lifecycle costs.

Reducing the energy requirements of aeration blowers will help plants cut their energy costs and CO<sub>2</sub> emissions. SKF's high-speed permanent magnet motor solutions that utilize magnetic bearings are already making it possible.

Magnetic bearing systems represent an innovative approach to the support of rotating equipment, achieving performance levels not previously possible with traditional rolling



**“Magnetic bearings are a non-contacting technology, offering a range of benefits from almost zero friction, active vibration control, reduced energy consumption and the elimination of bearing wear.”**

— Mark Hinckley, SKF Strategic Industries

element or fluid film bearing technologies. Magnetic bearings are a non-contacting technology, and as such they offer a range of important benefits, from almost zero friction, active vibration control, reduced energy consumption and the elimination of bearing wear. In addition, it is possible to operate at speeds that were unachievable with traditional technology. Magnetic bearings are ideal for use in processes that are sensitive to contamination since the need for lubrication and maintenance has been eliminated. For example, applications within the vacuum chambers of semiconductor manufacturing and hermetically sealed refrigeration compressors can and do benefit from the use of this technology.

### How Magnetic Bearings Work

The concept behind magnetic bearings has been around for many years and for a long time the use of the technology was limited to extremely specialized, unique or ultra-high speed applications. Developments in magnetic bearing technologies along with advancements in computing power have seen a reduction in the size of control systems and increases in system performance making magnetic bearings an excellent choice for a number of industrial applications.

There are three key components in a magnetic bearing system that work together to achieve this new level of performance. First the magnetic bearing itself consists of stationary (stator) components as well as rotating (rotor) components. These components create the magnetic field that will support and control the

rotor position. The second component is the position sensor. These sensors continuously monitor the position of the bearing rotor relative to the position of the bearing stator. The third component is the Magnetic Bearing Controller (MBC). This is the ‘brains’ of the system, taking the data from the position sensors and determining how much power it should deliver to each magnetic bearing in order to keep the system stable and under control.

The magnetic bearing stator consists of a stack of steel laminations that are wound with copper wire to form an electromagnet. In operation, a current is supplied to each coil of wire to produce an attractive force that levitates the shaft inside the bearing. The MBC applies the precise level of current to the coils determined by monitoring signals from the positioning sensors in order to keep the shaft at the desired position throughout the operating range of the machine. Depending on

**COMPRESSED AIR  
WE'RE IN!**

pages/Aircom-srl  
channel/aircomsystem  
aircomsrl

**aircom**

**Compressed Air and  
Fluid distribution systems**

Head Office and Warehouse:  
9805-M NorthCross Center Court  
Huntersville, NC 28078  
Ph. 704-987-2088 - Fax 704-987-2048

West Coast Store:  
885 Farway Drive  
Walnut, CA 91789  
Ph. 800-237-6247 - Fax 909-444-9585

Scan this code to visit:  
www.aircom.us.com

ISO 9001

## MAGNETIC BEARINGS: AN ATTRACTIVE FORCE FOR ENERGY-EFFICIENCY



### The PM Motors App from SKF

Download the **PM Motors App** from **SKF** from the Apple® App Store, scan the “trigger” image at left, and explore the complete SKF portfolio of high-speed permanent magnet motor solutions!

Get more details at [skf.com/PMmotors](http://skf.com/PMmotors)

the application, there is typically a 0.5 to 1 mm air gap between the bearing rotor and stator.

The position sensor registers any change in position of the shaft (rotor). This change in position is communicated back to the MBC where the signal is processed; the controller decides what the necessary response should be, then initiates a response from the MBC's amplifier. This response should then adjust the magnetic force in the corresponding electromagnet in order to bring the shaft back to center.

This process repeats itself over and over again. For many applications, the sample rate from the sensor can be 15,000 times per second, or 15 kHz. The sample rate is high because if the power to the magnet is left unchanged as the rotor moves closer to the magnet, the attractive

# ENERGY KAIZEN EVENTS

- Food Packaging Plant Saves \$70,000 or 1.1 Million kWh per year.
- Paper Mill Saves \$207,000 or 4.5 Million kWh per year.



Get your **FREE** Subscription to Compressed Air Best Practices® Magazine to **learn how to save energy.**

Subscribe at  
[airbestpractices.com](http://airbestpractices.com)

force will increase as the gap decreases. So the system continuously adjusts the magnetic strength coming from the electromagnets in order to hold the rotor in the desired position.

**The Application of Magnetic Bearings**

For centrifugal air blowers, few technologies can match the energy efficiency and reliability that’s possible with a permanent magnet motor (PMM), active magnetic bearings (AMB) and a variable speed drive (VSD). SKF has designed this advanced combination of components and technologies as a complete package solution that can help manufacturers streamline product design, development and assembly.

**Permanent magnet motor**

- Low energy use and cooling requirements
- High-speed capabilities in a compact design
- 10%+ more energy efficient than conventional motors at full load and part load
- Direct drive configuration eliminates gearbox and oil
- Optimized shaft geometry accommodates large impellers with robust rotor dynamics

**Active magnetic bearings**

- Accommodate instant and frequent start-ups and transient surge forces
- Active control system provides vibration-free performance
- Capable of speeds in excess of 40 000 rpm
- Levitate rotating components for friction- and lubricant-free performance
- Unitized radial and axial bearing modules enable compact packaging and robust performance

**Real-world success with SKF**

A wastewater treatment facility in France had been operating with four 80 kW lobe-type blowers with several issues, including frequent breakdowns, high energy consumption, high noise levels, and treatment process problems. After replacing the lobe blowers with two new centrifugal blowers that featured the SKF high-speed permanent magnet motor solution, the results were immediate — and dramatic.

The variable speed blowers incorporating the SKF solution simplified regulation of the flow rate, improving the treatment process significantly. Noise levels fell from 110

dBa to 70 dBa, and maintenance demands dropped considerably.

The bottom-line reductions in energy use were even more impressive. After only a year in operation, the blowers equipped with the SKF solution cut plant CO<sub>2</sub> emissions by 375 tons and operating costs by €54 000

**One-year savings with the SKF solution:**

- €54 000 in energy costs
- 500 000 kWh
- 375 tons of CO<sub>2</sub>



**Together, we can move clean air, guaranteed.** From the compressor outlets to the machines with optimal flow, minimal downtime and increased plant productivity.



Transair: Compressed air pipe systems 1/2" to 6"

When you partner with the global leader in compressed air pipe systems, expect to move your business and the world forward. From various fittings to highly integrated pipe systems, Transair’s aluminum pipe ensures higher longevity of equipment and avoids frequent changes of filtration elements. Not to mention, Transair’s energy savings element is critical to lowering your overall cost of ownership. So partner with Parker, and get ready to move clean air, guaranteed.



Scan to see a Transair video.



**ENGINEERING YOUR SUCCESS.**  
www.parkertransair.com ph 480 830 7764



A 360° VIEW OF THE MOST INNOVATIVE TECHNOLOGY AND PROCESSES. **FABTECH 2013.**

**METAL FORMING | FABRICATING | WELDING | FINISHING**

FABTECH represents every step of the metal manufacturing process from start to finish. It's where new ideas, products and technology are highlighted through interactive exhibits, education and networking. Compare solutions from 1,500+ exhibitors, find machine tools to improve quality and productivity, and learn ways to increase profit. **REGISTER NOW** for the show with a degree of difference.

**November 18–21, 2013 | Chicago, IL | [fabtechexpo.com](http://fabtechexpo.com)**



**North America's Largest Metal Forming,  
Fabricating, Welding and Finishing Event**

Cosponsors:



Scan code to  
watch video.



Follow us:



## MAGNETIC BEARINGS: AN ATTRACTIVE FORCE FOR ENERGY-EFFICIENCY

### Magnetic bearing controller

- Tracks and registers rotor position up to 15 000 times per second
- Controls rotor position to within a micron-sized orbit
- Continuously corrects rotor position by adjusting the power supplied to each electromagnet
- Instrumentation for integration into the blower control system

The data that is collected and analyzed by the MBC during normal operation can be used to help monitor and assess the performance of the system. Traditionally external vibration monitoring equipment would be required to collect this level of information but with magnetic bearings, it comes as part of the solution. Such active monitoring help not only to improve machine reliability, but also enable better decisions to be made based on what is known about a specific process. What you are able to measure, you are able to improve, so using the measurements captured here allows for troubleshooting and system enhancement activities.

By levitating the rotating components, SKF magnetic bearings enable a friction-free system that eliminates the need for lubrication. The result is a range of oil-free motor solutions that can deliver between 75 and 350 kW of power. As a leading global supplier of high-speed permanent motors, SKF can deliver complete standardized packages from a single source.

Compared to traditional lobe-type blowers, aeration blowers that utilize SKF high-speed permanent magnet motor solutions can offer:

- Lower total cost of ownership (TCO)

- 10 to 40% lower energy use
- Improved service life and reliability
- exceeds mean time between failure (MTBF) rates of 100,000 hours
- Reduced component wear and less maintenance
- An oil-free environment with no risk of contamination
- Up to 30% lower noise levels
- A smaller, more lightweight footprint
- Compliance with environmental regulations

- Worldwide SKF service network support

SKF High-speed permanent magnet motor solutions are helping blower manufacturers design and develop the next generation of highly energy-efficient, highly reliable centrifugal air blower units. This solution combines the cutting-edge technology of a high-speed permanent magnet motor, active magnetic bearings with an integrated control system and a variable speed drive. **BP**

To read more **Blower Technology** articles, visit [www.airbestpractices.com/technology/blowers](http://www.airbestpractices.com/technology/blowers)

## Measure, discover and save!

VPIstruments offers flow meters & energy management solutions for compressed air and industrial gases. Now you can find out where, when and how much you can save. Your piggy bank will be happier than ever before!



Contact your local distributor or  
US Office:  
740-862-0084  
sales@vpinstruments.us  
Main office:  
+3115-2131580  
sales@vpinstruments.com  
www.vpinstruments.com



# weftec® 2013

the water quality event™



# SHOW PREVIEW

By Compressed Air Best Practices®

► WEFTEC® 2013, presented as “the water quality event”, is taking place from October 5 to October 9, 2013 at McCormick Hall in Chicago. WEFTEC®, the Water Environment Federation’s Annual Technical Exhibition and Conference, is the largest conference of its kind in North America. Attendance is expected to be over 17,000 people.

WEFTEC 2012 featured a technical program of 148 technical sessions with over 1,000

presentations, 24 workshops. The exposition hosted an estimated 980 exhibitors occupying more than 285,000 square feet.

For our readers, we would like to recommend attending the October 5 workshop titled, “No Nonsense Data: Wire-to-Air Blower Power.” This workshop will provide in-depth information on the new ASME PTC-13 Blower Standard.

Compressed Air Best Practices® Magazine is proud to be “A Supporting Publication” of

WEFTEC®. This industry is a major user of aeration blowers and air compressors. We will be exhibiting at the show and distributing this issue to show visitors. We hope this article can help show visitors find blower and compressed air system manufacturers at WEFTEC® 2013.

**Hoffman & Lamson (Booth 1412)** The Hoffman Revolution is the world’s most advanced blower energy management system, setting new standards in efficiency and

**Table 1. Blower and Air Compressor Technology Exhibitors at NPE 2013**

| COMPANY                                   | TECHNOLOGY* | BOOTH NUMBER | COMPANY                 | TECHNOLOGY* | BOOTH NUMBER |
|---|-------------|--------------|-------------------------|-------------|--------------|
| Aerzen                                    | B, AC       | 4044         | Kaeser Compressors      | B, AC       | 4020         |
| APG-Neuros                                | B           | 3239         | PillAerator             | B, AC       | 1267         |
| Atlas Copco                               | B, AC       | 4448         | Q-VAC Priming Systems   | B           | 4155         |
| Continental Blower                        | B, AC       | 3045         | Robuschi                | B, AC       | 1825         |
| EURUS Blower                              | B, AC       | 5641         | Siemens                 | B           | 1431         |
| Hoffman & Lamson, Gardner Denver Products | B, AC       | 1412         | Spencer Turbine Company | B           | 921          |
| GE Roots                                  | B           | 4663         | Sulzer Pumps/ABS        | B           | 2362         |
| Geotech Environmental Equipment           | B, AC       | 1839         | United Blower           | B           | 4635         |

\*B – Blowers, AC – Air Compressors





Booth 1412: Hoffman™ Revolution High Speed Centrifugal Blower

environmental protection. It is the first high speed centrifugal in its class that is designed, built and tested in the United States of America.

The Revolution delivers up to 45% energy savings, provides increased reliability with little or no maintenance, and is factory prewired and tested in an ergonomically designed sound enclosure for plug-and-play operation. Technology improvements allow the footprint of the Revolution to be significantly smaller than traditional blowers, which reduces installation costs and enables the Revolution to function in places traditional blowers cannot. It is the quietest high-speed blower in its class with a one meter certified sound rating at below 80 dBa.

[www.HOFFMANandLAMSON.com](http://www.HOFFMANandLAMSON.com)

**Aerzen (Booth 4044)** Aerzen presents the AT Turbo blower Generation 5 — designed specifically for municipal and industrial water treatment plants. This series is available in 11 sizes and with suction volumes of approx. 4.000 m<sup>3</sup>/h up to 13.200 m<sup>3</sup>/h, pressure ranges of 400 mbar up to 100 mbar and motor sizes up to 300 kW.

[www.aerzenusa.com](http://www.aerzenusa.com)

**Kaeser Compressors (Booth 4020)** It's no secret that factory-built blower and compressor packages provide distinct benefits and savings. That's why wastewater treatment plants across the country rely on industry leader Kaeser Compressors, Inc. for their blower and compressed air needs. For design packages that include a complete scope of supply with



Booth 4044: Aerzen AT Turbo Blower

motors, drives, valves, enclosures, and instrumentation, you can count on Kaeser for simplified installation, reduced maintenance costs, and years of trouble-free performance.

# CLEAN RESOURCES

## CRP Oil/Water Separators that Work

100% of the time on 100% of compressor lubricants

No Maintenance

Guaranteed to reduce effluent to less than 10 ppm

EPA Compliant



Clean Resources • [www.cleanresources.com](http://www.cleanresources.com) • 800-566-0402

## WEFTEC® 2013 SHOW PREVIEW



Kaeser's Com-pak BB52C will be running at booth #4020.

Kaeser's Omega blower packages are perfectly suited for wastewater service. In addition to excellent reliability, they offer side-by-side installation with a compact design that's built for a lifetime™. Sound dampening and anti-vibration features bring noise levels down so low you won't believe they're running.

Kaeser will be showing blower packages from their BBC, DBC, and CBC blower lines, as well as an AirCenter air compressor package and SmartPipe™ air distribution system. Stop by booth #4020 to learn why Kaeser is the compressed air specialist.

[www.kaeser.com](http://www.kaeser.com)



Booth 4448: Atlas Copco ZS Screw Blower

**Atlas Copco (Booth 4448)** Atlas Copco Compressors will showcase its reliable, energy-efficient blower technology at WEFTEC 2013, including the ZS range of low pressure screw blowers that provides a 30% increase in energy efficiency over traditional rotary lobe blowers. Other products on display will include multistage centrifugal blowers, high speed turbo blowers and the ZB range of centrifugal blowers.

Atlas Copco Compressors manufactures markets and services oil-free and oil-injected stationary air compressors, air treatment equipment and air management systems. During the past five years, Atlas Copco has



Booth 5641: Eurus Tri-lobed ZG Blower

### Aeration Blower and Compressed Air System Technology Exhibitors Can Help WWTP's Reduce Energy Costs

We highly recommend that wastewater treatment professionals take the time to review their compressed air and blower aeration systems by visiting one of the exhibitors at WEFTEC®.

Julie Gass P.E., Lead Process Mechanical Engineer from Black & Veatch, said the following in our interview article in this issue; "Aeration blowers consume 40 to 70

percent of the over-all energy consumption at a wastewater treatment plant (WWTP). For those of us designing or retrofitting WWTP aeration blower systems, we are faced with a major design challenge. We must design aeration blower systems that will meet peak load requirements that occur perhaps one day a year- yet operate efficiently the rest of the year under ever-changing partial-load conditions."

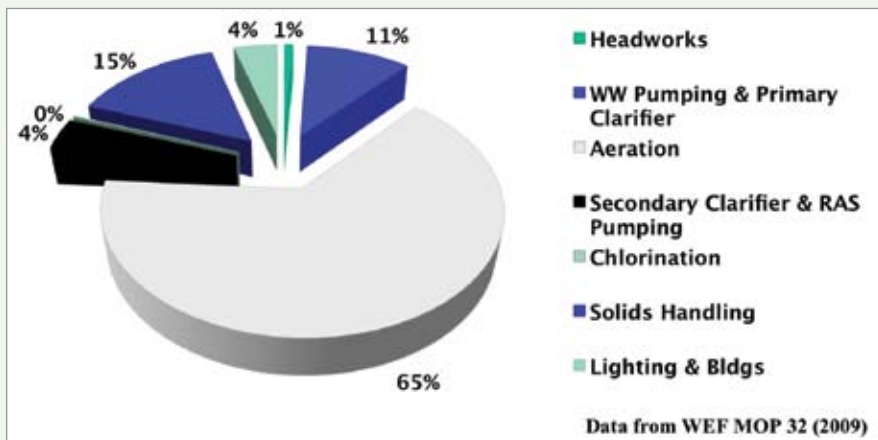

Aeration Can Represent 65% of WWTP Energy Use (Graph courtesy of Aerzen USA. Data from WEF MOP 32 (2009))

invested in new facilities to further support manufacturing, distribution and training for customers nationwide, while providing 24/7 access to service and maintenance.

*www.atlascopco.us*

**Eurus Blower Inc. (Booth 5641)** Eurus Blower is a wholly owned subsidiary of China's largest blower manufacturer, Shandong Zhangqiu Blower Co. Eurus Blower was founded in 2008 with the principle of providing very high quality, dependable blowers and blower packages to the US market at highly competitive prices. With Shandong's 40 plus years of experience producing PD blowers, it allows us to offer our customers blowers constructed in high quality cast iron, both bi-lobed and tri-lobed for all types of aeration applications. We provide blowers and blower packages with capacities of up to 50,000 cfm and pressure ranges up to 23 psi.

Our blowers will be on display at WEFTEC in booth 5641.

*www.eurusblower.com*

**United Blower, Inc. (Booth 4635)** United Blower Inc. (UBI) will exhibit at WEFTEC 2013 two innovative AMERICAN manufactured blower systems.

- P.D. blower system will have a sound enclosure with a noise level of 75-82 dbA. UBI's P.D. blower includes all the features of a high quality P.D.
  - Trilobes with Pulsation Control Channels
  - Helical Timing Gears
  - Piston Ring Air and Oil Seals
  - Oil Lubricated Bearings and Gears
  - Extremely Heavy Duty Construction
  - Operates at lower speed than any of our competitors, offering similar high quality blowers
- High speed direct drive, oilless, VFD controlled, TURBO blower, with a sound enclosure

## REVOLUTION

The One You Want



**The** world's most advanced energy management system.

**One** hundred percent designed, built and tested in the USA.

**You** benefit from 45% energy savings through advanced technologies.

**Want** green technology to take your aeration plant to the next level?



Visit Us at  
**WEFTEC**  
Booth 1412

www.  
**HOFFMAN**  
and  
**LAMSON**  
.com

## WEFTEC® 2013 SHOW PREVIEW

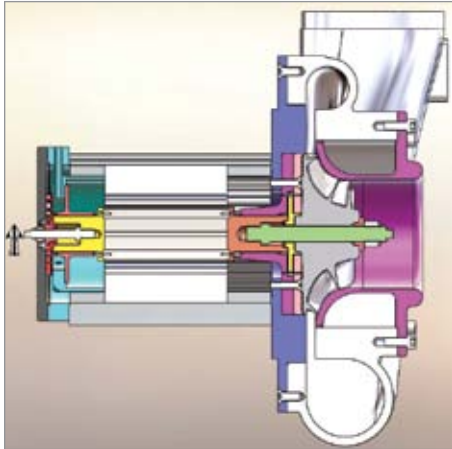

Booth 4635, United Blower High-Speed Turbo Blower

- This turbo is unlike any other turbo. It is completely American manufactured and not assembled from foreign parts
- All instruments and controls are also American made
- Our turbo is one of the most efficient (WTA) turbos. For example, no hot cooling air enters the impeller

UBI would be most pleased to show our American-made systems to our valued customers. Our highly technical staff will answer your questions!

[www.unitedblower.com](http://www.unitedblower.com)

**APG-Neuros (3239)** APG-Neuros offers efficient and affordable Direct Drive high speed turbo blowers and aeration systems

for municipal and industrial customers. With over 700 units installed in North America, APG-Neuros offers the most proven product supported by a strong engineering and well established service networks spread across US and Canada. Its Award Winning High Speed Turbo Blowers are considered as the industry reference for high quality thanks to the use of the most advanced and proven air bearing, motor and blower aeration control system technologies. Customer benefits include energy savings of up to 35%, elimination of heat rejection, vibration-free operation, noise reduction, smaller footprint and lower installation costs compared to conventional products. APG-Neuros' turbo blowers can attain flow rates up to 25,000 scfm, up to 15 psig design discharge pressure and can provide up to 76% flow turn-down with its innovative dual core models.

[www.apg-neuros.com](http://www.apg-neuros.com)



Booth 3239: APG-Neuros Turbo Blower



Booth 2362: Sulzer Pumps/ABS Turbocompressor HST20

**Sulzer Pumps/ABS (Booth 2362)** Sulzer Pumps' ABS Turbocompressor HST 20 now sets the standard for direct drive high speed turbocompressors! This is the only turbocompressor with built in inlet and outlet air silencers (less than 70 dBA). With the best wire to air efficiency (advanced permanent magnet motors & digitally controlled magnetic bearings), an intuitive human-machine interface (HMI), advanced magnetic bearings & bearing control coupled with a self diagnostic control system which optimizes performance and overall lower operating cost.

[www.sulzer.com](http://www.sulzer.com), [www.abseffex.com](http://www.abseffex.com)

**PillAerator (Booth 1267)** The German designed and engineered, PillAerator high speed turbo blower is a fully plug and play blower designed with magnetic bearings suitable for unlimited starts and stops. Due to the features designed into each blower, users of the PillAerator benefit from lower power



Booth 1267: PillAerator High Speed Turbo Blower

cost and minimum down time compared to other high speed blowers on the market. The PillAerator is fully packed with a PLC control system to allow customers to maintain a tight tolerance based on DO or Pressure levels with additional capability to sequence multiple

blowers all operating at their most efficient condition. The PillAerator is 200 hp or 400 hp blower with its wide operating range exceeding 50% has satisfied needs from 2 MGD up to and including a 80 MGD plant.

[www.piller-tsc.com](http://www.piller-tsc.com)

**Roots (Booth 4663)** GE Oil & Gas offers Roots blowers, compressors and controls, innovative, advanced air and gas handling products ranging in size and features from small and large rotary lobe blowers and standard blower and compressor packages to custom blower and compressor packages and centrifugal compressors and controls systems. Roots blowers and compressors technology is built on a heritage of engineering

and manufacturing expertise dating back to the Roots brothers' discovery of the principle of the rotary positive displacement blower in 1854. Today, Roots aeration controls systems technology delivers customers savings of up to 40 percent of the energy used for WWTP aeration.

[www.ge-energy.com/products\\_and\\_services](http://www.ge-energy.com/products_and_services)

We look forward to seeing you at WEFTEC 2013 in Chicago! **BP**

For more **Wastewater Industry** articles, visit [www.airbestpractices.com/industries/wastewater](http://www.airbestpractices.com/industries/wastewater)



Booth 4663: Roots Turbo Blower



**THE POWER OF PROVEN TECHNOLOGY**

United Blower, Inc has been in business since 1989 and is located in the Atlanta, GA area. UBI manufactures its own PD blower systems featuring tri-lobe PD blowers. UBI also manufactures high speed turbo blowers, gas compressors, regenerative and screw blowers, complete systems.



**"Quiet Pulse"  
Compact PD Blower Package  
with 3 Panel Access**



- Noise Enclosures**
- Walk-In
  - Close-Fitting
  - Fiberglass

UNITED BLOWER  
1198 Airport Drive  
Ball Ground, GA

Phone: 770-479-3000  
Fax: 770-479-3111  
E-mail:  
[sales@unitedblower.com](mailto:sales@unitedblower.com)

# Q&A: APG-Neuros and Turbo Blower Technology

By Rod Smith, Compressed Air Best Practices® Magazine

► Compressed Air Best Practices® Magazine interviewed Mr. Omar Hammoud, the CEO and President of APG-Neuros.

## Good afternoon. How and when was APG-Neuros founded?

Good afternoon. APG-Neuros was founded in 2006 in Quebec as a result of seeing an opportunity for innovation in the North American blower market. Our mission is to distribute, manufacture, provide aftermarket support and continued development of high-efficiency turbo blowers and complete Aeration Systems for the municipal and industrial markets in North America and Europe.

APG-Neuros is a joint company between my other company, Aviation and Power Group (APG), and Neuros Company LTD. The company's recently completed headquarters/production facility is located in Blainville, Quebec, with another production facility that serves the US market in Plattsburgh, New York.

## CASE STUDY: Lakota WWTP, Lakehaven Utility District, WA

*High energy consumption and limited and inefficient operation*

Lakota WWTP, WA, secured an Energy Conservation Grant to replace Positive Displacement Roots blowers with a more energy efficient APG-Neuros Turbo Blower that reduced power consumption by 50%.

**Location:** Lakehaven  
Utility, District —  
Federal Way, WA

**Energy Grant:** \$156,110

**Project cost:** \$221,924

**Availability level:** Close to 100%

**Application:** WWTP - Aeration  
Activated Sludge

**Installed:** June, 2008

**Model:** NX300-C080 (1)

**Annual Savings:** \$86,811

**Payback Period:** 1.3 years

## Challenge

Like many wastewater treatment plants across the country today facing high energy costs and aging equipment, the Lakota Wastewater Treatment Plant sought options to address their challenges while moving towards a more environmentally conscious operation. The plant was equipped with



Positive Displacement Blower

two Positive Displacement Roots blowers (250 hp and 350 hp) used to supply air to the biological secondary treatment process. In service for almost 17 years, the 250 hp blowers were noisy and inefficient, consuming a lot of energy to meet plant's air and pressure requirements. Due to its operational inflexibility, the 250 hp blower was unable to meet the low pressure aeration flow requirements of the plant, obliging the plant operator to turn on the second 350 hp blower, resulting in additional power consumption.

### Solution

In 2008, the Lakota WWTP replaced the 250 hp P.D. blower with APG-Neuros' 300 hp turbo blower. The blower replacement project was eligible for an Energy Grant from Puget Sound Energy (PSE). With APG-Neuros' help, after thorough review of the estimated energy savings, and PSE agreed to finance 70% of the project capital cost, providing grant funds of over \$156,000. The APG-Neuros turbo blower saved the WWTP over \$86,000 per year in power consumption (at 7.5 cents/kWh), which resulted in a payback period of 1.3 years (with grant funding from PSE). In addition to the energy savings, the turbo blower reduced the power demand by 1380 kWh/yr. The NX300 is able to supply all of the plant's low pressure process aeration requirements that eliminate the need

to run the 350 hp P.D. blower. Reducing operation from 2 units (250 hp and 350 hp) to one unit (NX300), demonstrates the operational flexibility with variable flow and variable pressure requirements. The plant PLC communicates with the blower's built-in PLC to control its speed, to maintain a pressure set point, and adjust flow, set point corresponding to the varying water depths and pressures. The plant PLC monitors the D.O. levels in each basin, regulating the motorized valves on supply headers to each section of tanks as needed, adjusting air flow to maintain the D.O. set points. The APG-Neuros Turbo Blower provided an exceptional reliability with availability level exceeding 99.8% over four years and 35,000 operating hours.



New APG-Neuros Turbo Blower



Replaced Positive Displacement Blower

## HOW BIG IS YOUR CARBON FOOTPRINT?



Now you can measure your carbon footprint savings with UE Systems patented Compressed Air Leak Survey Report Software.

Manage your ultrasonic leak surveys, cut energy waste, improve the environment and your bottom line.

**ue**  
SYSTEMS INC  
The *ultra*sound approach

Learn how: [www.uesystems.com/new/CA2](http://www.uesystems.com/new/CA2)

[info@uesystems.com](mailto:info@uesystems.com) • [www.uesystems.com](http://www.uesystems.com) • 1-800-223-1325

# FREE SUBSCRIPTION

DIGITAL EDITION FREE WORLDWIDE | PRINT EDITION FREE TO U.S. SUBSCRIBERS



## COMPRESSED AIR BEST PRACTICES

airbestpractices.com

Join Us On The Road To Saving Energy & Improving Productivity In YOUR Industry!

### 2013 FOCUS INDUSTRIES:

- Energy: Biogas
- Food Packaging & Containers
- Plastic Blow Molding
- System Assessments
- Energy: Compressed Natural Gas
- Pneumatic Conveying
- Compressed Air System Automation
- Wastewater Treatment
- Food Processing
- Metal Fabrication & Machining
- Air Compressor Controls

Subscribe at [airbestpractices.com](http://airbestpractices.com)



## Q&A: APG-NEUROS AND TURBO BLOWER TECHNOLOGY

### CASE STUDY:

#### NAPA Valley Sanitation District, CA WWTP

**Location:** NAPA Sanitation  
District, CA

**Model:** NX300-C080

**Installed:** September, 2008

**Application:** WWTP — Aeration  
Activated Sludge

**Availability Level:** close to 100%

**Project Cost:** \$382,700

**Energy Grant:** \$110,000

**Annual Savings:** \$114,251

**Payback Period:** 2 years

### Inefficient Operation & Turndown

NAPA Sanitation District's consultant QuEST and Herwitz Engineering conducted a study on replacing the plant's Multistage Centrifugal blowers to address their inefficient operation, operational inflexibility and high energy consumption. Following the recommendation of the study, NAPA Sanitation District replaced their existing blowers with the High Efficiency turbo blowers which helped them secure a rebate by CalPOP.

### Challenge

Although the peak efficiency of the multistage centrifugal blowers that the plant was equipped with was rated at 74% at their design point, the actual annual flows of the plant required the plant operators to blow off excess air to meet turndown requirements, significantly lowering the efficiency of the blowers. Furthermore, although the average annual flow was around 8 MGD, the peak wet weather flows reached up to 32 MGD. The existing multistage blowers were rated for peak flow conditions, resulting in wasted



*APG-Neuros Turbo Blower and PD Blower side-by-side*

air during typical operation. Wasted air = wasted energy.

### Solution

Herwitz Engineering and the district's consultant QuEST evaluated nine months of historical plant operation data to determine potential energy saving alternatives for the Soscol Water Recycling Facility, for Napa Sanitation District. In 2008, the final audit report recommended to replace two of

the existing aeration 350 hp multistage centrifugal blowers with higher efficiency Turbo Blowers. The report studied various options for the plant's blower replacement in order to achieve energy savings. QuEST estimated that installing high efficiency turbo blowers in place of the multistage ones would result in annual energy savings of \$114,251. The agency also evaluated the option of replacing the existing blowers with a new positive displacement (P.D.) blower equipped with a VFD to allow for a more flexible operation.

Finally, the report concluded that the turbo blower would offer almost twice the energy savings than the proposed P.D. blower at \$62,318 in annual savings. Although the P.D. initially offered a lower capital cost alternative, the net capital investment for the Turbo Blower could be recovered in less than two years due to the difference in energy savings. Moreover, the savings on maintenance, system reliability, and quiet



*Aeration Basins at NAPA Sanitation District*

## Q&A: APG-NEUROS AND TURBO BLOWER TECHNOLOGY



*APG-Neuros Turbo Blower*

operation confirmed the turbo blower would be the best choice for the plant to maximize overall system efficiency. The district decided

to move forward with replacing their multistage blowers with a high efficiency turbo blower and were rewarded a rebate by CalPOP of approximately \$110,000.

NAPA Sanitation District followed the evaluated bid process to select and procure their new turbo blowers. This innovative bid process allowed the district to receive competitive bids and make their selection based on evaluation factors. The evaluation committee recommended the selection of APG-Neuros' turbo blowers based on overall value that took into account the higher energy savings, quality of construction and local support.

In September 2008, the existing multistage centrifugal blowers were replaced with the APG-Neuros high efficiency blowers, immediately reducing the input power by

50 hp. The NX300-C080 blowers were designed to meet the plant's annual flow range and to optimize the blower's performance to maximize energy savings. The turbo blowers have been in operation since, with the only scheduled maintenance of changing the intake filters as needed. The facility is saving well over one hundred thousand dollars a year from the reduction in energy consumption, labor hours and spare parts.

The benefits from retrofits of conventional blowers such as at Napa Sanitation District, not only lower energy bills, reduce noise, and reduce maintenance requirements, but also contribute to a larger environmental cause: reduce greenhouse gas emissions, demand on electric utility systems, and dependence on oil.

### Where does your experience with turbo blowers come from?

APG-Neuros' turbo blower technology was founded in the aerospace and defense industry where aero engines were used in Unmanned Aerial Vehicles (UAV) and in the F-16 military aviation program, making the technology tested and reliable. The core of the technology is the bump foil air bearing which is oil-free and non-contact, needing no lubrication or associated maintenance thereby resulting in lower vibration from the rotor during operation. Its' proven durability and endurance have been demonstrated through 25,000 starts; equivalent to more than twenty years lifetime in a typical operation!

### Please describe the market's acceptance of turbo blowers.

Numbers are sometimes the best way to describe a market's acceptance of a new innovation. We grew from one turbo blower unit in 2006 to now having over 700 units installed in the U.S. and Canada. Most of our installations (85%) are in the U.S. and Canada, with seven percent in Mexico and eight percent in Europe.

Blower distributors need to sell high quality and high value products. Instead of allowing contractors to focus on a lump-sum price for a project, they must teach them to take advantage of higher technology with lower lifecycle costs. Distributors have to do

the groundwork to educate the consulting engineers and end users so they will focus on the best solutions.

We have worked very hard with our North American distributors, to transform the market through education. Over time, design engineers and wastewater treatment plants (WWTP) have modified their specifications to focus on quality and lifecycle costs of a blower aeration system. We believe that today ninety percent of specifications now focus on these two major factors.

We have distributors covering North America (U.S. and Canada). Our distributors came from large companies willing to change

When you make the effort to travel to a show, you're looking for concentrated information from suppliers to your industry.

# Food & Beverage. Full-Strength.

No other North American show can match PROCESS EXPO's fixed focus on food & beverage processing and packaging.

You'll see over 500 industry-focused exhibitors – including top equipment manufacturers. Learn from industry and academic experts in timely, educational sessions. Watch solutions at work on the show floor.

**Food & beverage solutions. Straight up.**



NOVEMBER 3 - 6  
2013 | CHICAGO  
McCormick Place  
South Hall/North Hall

**REGISTER NOW**  
[www.myprocessexpo.com](http://www.myprocessexpo.com)

CO-LOCATED WITH  
INTERNATIONAL  
**DAIRY  
SHOW**  
2013

**PROCESS  
EXPO**

**FPSA**

Food Processing  
Suppliers Association

The GLOBAL  
**FOOD EQUIPMENT  
& TECHNOLOGY SHOW™**

## Q&A: APG-NEUROS AND TURBO BLOWER TECHNOLOGY

to work with a new product that added significance and value to their current product offerings. Thanks to our mutual efforts, APG-Neuros has established a strong brand name.

### What are the primary customer benefits of a turbo blower?

The High Efficiency Turbo Blower is a “plug and play” product that’s ready to use at the point of delivery with a very quick and easy installation. Everything is pre-assembled and pre-integrated inside the unit in a rigid and hermetic enclosure. Our unit has a 25% smaller footprint than conventional blowers, and can be installed outdoors under a protective shelter in the most extreme climate, both hot and cold. They are also equipped with an easy to operate touch screen (PLC) for easy control, monitoring and diagnostics on the process parameters and blower conditions.

Finally, the turbo blower is an efficient, oil-free and environmentally sustainable product providing end users with significant reductions in operating costs through energy savings of up to 40% (according to a third party study) and low installation and maintenance costs — only air filters need periodical cleaning or changing. Other

important benefits include much lower noise and vibration, durability, and reliability.

The turbo blowers are designed to provide up to 20,000 scfm with a pressure able to reach 15 psig according to the capacity of the engine from 30 to 600 hp. The “Dual Core” units, NX400 to NX700 (700 hp) produce 3,000 to 20,000 scfm with two turbo blower cores operating within the same enclosure. This makes it possible to considerably reduce the space footprint compared to the conventional technologies.

### Please describe your emphasis on quality.

Quality is critical because, without it, lower lifecycle costs cannot be achieved by the WWTP. Leveraging our experience with military aviation, APG-Neuros believes third-party controls are necessary to ensure quality. We worked with CSA and with UL to create standards to certify blowers. The UL witness-tested the energy efficiency of our turbo blowers. We can also provide the CE mark complying with the CE Machinery Directive in Europe. Today, every product leaving our facility has both CSA and UL marks on it. Consulting engineers can take advantage of this.

Each certification had a project team that took 2 ½ years to complete the requirements. Our facilities have state-of-the art testing facilities. These investments support our quality claims and allow consulting engineers to take advantage of our lower lifecycle costs.

### Speaking of testing, what do you think of the new ASME and CAGI blower standards coming out?

ASME PTC-13 and ISO 3859 Annex G will have a very positive impact on quality and lower lifecycle costs for wastewater treatment plants. AP-Neuros is a member of working committees for both standards and is a strong supporter of both standards. We have contributed our knowledge and experience with turbo blowers as we have been pioneers in the development of turbo blower package test procedure. We are doing the final verifications right now on turbo blower test procedures for the ASME standard.

### Thank you for your time.

For more information visit [www.apg-neuros.com](http://www.apg-neuros.com), email: [customerservice@apg-neuros.com](mailto:customerservice@apg-neuros.com), tel: 1-866-592-9482

To read more **Blower Technology** articles, visit [www.airbestpractices.com/technology/blowers](http://www.airbestpractices.com/technology/blowers)



**“Our unit has a 25% smaller footprint than conventional blowers, and can be installed outdoors under a protective shelter in the most extreme climate, both hot and cold.”**

— Omar Hammoud, CEO and President, APG-Neuros



# RESOURCES FOR ENERGY ENGINEERS

## TECHNOLOGY PICKS

### New Atlas Copco GA 160+ / GA 200-315 Range of Oil-Injected Screw Compressors

Atlas Copco Compressors has introduced a new GA 160+ / GA 200-315 range of energy efficient oil-injected screw compressors that feature a new single stage element that improves performance by up to 21% compared to the previous generation. Integrated with both the Elektronikon controller and an available energy recovery system, the new range provides advanced system monitoring and increased energy savings.



“Our customers demand sustainable, innovative solutions that help increase productivity while reducing energy consumption,” said Tom Poot, vice president – business line manager, Oil-Free Air Division, Atlas Copco Compressors. “With the new GA 160+ / GA 200-315 introduction we will continue to deliver high quality compressed air at the lowest operating cost.”

Designed for applications up to 131°F, the new GA 160+ / GA 200-315 package reduces the compressor’s footprint by 5%, while incorporating new features such as an oil-containing frame and an electronically controlled water drain. The full feature GA range offers an integrated solution that delivers clean, dry air and improves the system’s reliability, leading to longer service intervals and reduced maintenance costs. When combined with an easy installation, these features reduce the total operating cost of the compressor.

*Learn more at [www.atlascopco.com](http://www.atlascopco.com)*

### New Kaeser BSD 40-60 hp Rotary Screw Compressors

Kaeser Compressors, Inc. has yet again pushed the boundaries of compressed air efficiency with the newly redesigned BSD rotary screw compressors series. Available in 40, 50, and 60 hp with flows from 157–294 cfm and pressures to 217 psig, the new BSD compressors deliver “built-for-a-lifetime” reliability, simple maintenance, and sustainable energy savings.

Kaeser has further enhanced the BSD series’ energy efficiency through a combination of true direct drive design, premium efficiency motors, lower internal pressure differential, and optimized airends. Specific power is improved by up to 6%. In addition, built-in heat recovery options bring the energy savings potential to the next level.

New features include an enhanced cooling design, eco-friendly filter element, integral moisture separator with drain, and an Electronic Thermal Management system. BSD compressors also come standard with Sigma Control 2. This intelligent controller offers unsurpassed compressor control and monitoring with enhanced communications capabilities for seamless integration into plant control/monitoring systems. BSD models are also available with an integrated dryer for premium compressed air quality.



*To learn more about the new BSD series, visit [www.kaesernews.com/bsd](http://www.kaesernews.com/bsd) or call 877-586-2691*

## RESOURCES FOR ENERGY ENGINEERS

### TECHNOLOGY PICKS

#### New Sullair SP Oil/Water Separators Guarantee of Less Than 10 PPM Oil Carryover



Sullair announces the availability of its SP Oil/Water Separators, the versatile, high performance filtration units that are designed to control liquid condensate containing oil and various other contaminants created by compressed air systems. The fact is, studies have shown that a typical 1000 cfm compressor with refrigerated dryer can

produce over 57,000 gallons of condensate per year. Left unfiltered, this contaminated condensate can cause environmental issues and represents a threat of substantial regulatory penalties and costly, time-consuming remediation.

Engineered as a practical, cost-effective solution for condensate discharge problems, Sullair SP Oil/Water Separators are designed specifically for molecular filtration of condensate, including emulsified lubricants produced by compressed air equipment, where they have a 100% performance guarantee of less than 10 ppm oil carryover. Sullair SP Oil/Water Separators are furnished in three highly efficient, maintenance-free models: SP-25, SP-40 and SP-60. These models range from 20 to 3000 scfm maximum compressor capacity, and provide a working temperature range of 30°F minimum to 155°F maximum.

Featuring rugged HDPE construction, Sullair SP Oil/Water Separators are easy to install and are virtually maintenance free. All SP models contain a high quality media substrate that is formulated to attract and restrain contaminants while repelling water molecules. Unlike gravity-type separators, Sullair SP Oil/Water Separators require no pumps, sensors or pre-separation filter pads. Condensate from the waste stream simply flows through the media bed where lubricants are trapped, and cleansed water flows to the outlet. Fumes, odors and messy element changes are virtually eliminated. When water turns cloudy, or the unit change period is reached, SP unit disposal can be easily arranged through routine waste management pick-up service.

Visit [www.sullair.com](http://www.sullair.com)

#### New Festo DSBC Pneumatic Cylinders Save Design/Installation Time and Improve Motion Performance

Festo introduces the new DSBC family of ISO 15552 standard pneumatic cylinders, all of which feature the company's unique PPS self-adjusting cushioning capability. PPS ensures that cushioning into the end position is dynamic, but gentle, and requires no manual intervention. PPS eliminates the time consuming back and forth typically required during the adjustment stage of installing pneumatic cylinders.

The DSBC has the reliability and sturdiness of the popular ISO 15552 standard Festo cylinders DNC and DNCB and takes those actuators one step further with its unique self-adjusting cushioning capabilities. This self-adjusting ability ensures optimum cushioning performance at all times without the need for any manual intervention — even for changes in parameters such as friction and pressure, thus reducing wear and vibration.

A wide range of configuration options are available for the following:

- Seals, including chemical resistant
- Scrapers, including those optimized for high dust areas, i.e. packaging
- Safety, including rod clamp or mechanical end lock
- Low friction or slow speed
- Environments — low to high temperature conditions and high moisture, including wash down.

A bumper has been integrated into the DSBC seal for both noise and vibration reduction. Sizes range from 1.25 to 5 inches (32 to 125 millimeters).

“The overall capabilities, wide range of options, and the fact it meets the ISO 15552 standard makes the DSBC ideal for those OEMs seeking the benefits of standardizing on a single family of pneumatic cylinders – shorter engineering time, smaller inventory, less training, and, in the case of DSBC,



## TECHNOLOGY PICKS

improved performance,” said Frank Langro, director marketing / product management. “The Festo online product configurator makes ordering quick and efficient. In terms of the total package, no one in the pneumatics industry offers a family of cylinders comparable to the DSBC.”

*For more information on the innovative Festo DSBC ISO 15552 standard pneumatic cylinders with PPS cushioning, call Festo at 800-993-3786 and visit <http://www.festo.com/us>*

### Ingersoll Rand Releases New Extended Life Rotary Compressor Lubricant

Ingersoll Rand has launched an extended life rotary compressor lubricant, Ultra EL. This advanced synthetic rotary lubricant performs up to 16,000 hours — twice as long as other synthetic rotary lubricants — to increase uptime and reduce life-cycle costs.



Ingersoll Rand Ultra EL is a high-performance lubricant blend that provides advanced cooling technologies that allow air compressors to run cooler and more efficiently — even in high ambient temperature environments. Ultra EL also reduces wear and increases component longevity, increasing overall compressor performance.

Ultra EL is best suited for high-demand, multi-shift applications. When used in demanding environments, Ultra EL helps cut change-out frequency in half which maximizes uptime and lowers the facility's maintenance needs, disposal costs and environmental impact. Ultra EL also prevents critical compressor components from varnishing which further increases the longevity of the compressed air system. In addition to saving time and money, Ultra EL has a higher flash point (522 °F) than most synthetic lubricants.

“Ultra EL lubricant is compatible with Ingersoll Rand Ultra Coolant and can be used in most brands of rotary screw compressors,” said Ryan Cook, aftermarket leader – North America, Ingersoll Rand. “This makes it easy and cost-effective for compressor owners

## COMPRESSED AIR BEST PRACTICES® www.airbestpractices.com

### ADVERTISER INDEX

| Company                         | Page                  | Web Site   |
|---------------------------------|-----------------------|--|
| Kaeser Compressors              | Outside<br>Back Cover | <a href="http://www.kaeser.com/CABP">www.kaeser.com/CABP</a>                       |
| Association of Energy Engineers | Inside<br>Back Cover  | <a href="http://www.energycongress.com">www.energycongress.com</a>                 |
| Atlas Copco                     | Inside<br>Front Cover | <a href="http://www.energycblowers.com">www.energycblowers.com</a>                 |
| Hitachi                         | 3                     | <a href="http://www.hitachi-america.us/ice/atg">www.hitachi-america.us/ice/atg</a> |
| SPX Hankison                    | 7                     | <a href="http://www.spx.com">www.spx.com</a>                                       |
| WEFTEC                          | 8                     | <a href="http://www.weftec.org">www.weftec.org</a>                                 |
| BEKO Technologies               | 9                     | <a href="http://www.bekousa.com">www.bekousa.com</a>                               |
| E+E Elektronik                  | 10                    | <a href="http://www.epluse.com">www.epluse.com</a>                                 |
| JORC Industrial                 | 11                    | <a href="http://www.jorc.com">www.jorc.com</a>                                     |
| Aerzen                          | 13                    | <a href="http://www.aerzenusa.com">www.aerzenusa.com</a>                           |
| Hydrothrift                     | 14                    | <a href="http://www.hydrothrift.com">www.hydrothrift.com</a>                       |
| BOGE Compressors                | 15                    | <a href="http://www.boge.com/us">www.boge.com/us</a>                               |
| CDI Meters                      | 17                    | <a href="http://www.cdimeters.com">www.cdimeters.com</a>                           |
| Ingersoll Rand                  | 19                    | <a href="http://www.ingersollrandproducts.com">www.ingersollrandproducts.com</a>   |
| Anest Iwata                     | 21                    | <a href="http://www.anestiwata.com">www.anestiwata.com</a>                         |
| Festo                           | 23                    | <a href="http://www.festo.com/us/airquality">www.festo.com/us/airquality</a>       |
| Vaisala                         | 24                    | <a href="http://www.vaisala.com/compressedair">www.vaisala.com/compressedair</a>   |
| Sullivan Palatek                | 25                    | <a href="http://www.sullivanpalatek.com">www.sullivanpalatek.com</a>               |
| Aircom                          | 27                    | <a href="http://www.aircom.us.com">www.aircom.us.com</a>                           |
| Parker Transair                 | 29                    | <a href="http://www.parkertransair.com">www.parkertransair.com</a>                 |
| FABTECH                         | 30                    | <a href="http://www.fabtechexpo.com">www.fabtechexpo.com</a>                       |
| VP Instruments                  | 31                    | <a href="http://www.vpinstruments.com">www.vpinstruments.com</a>                   |
| Clean Resources                 | 33                    | <a href="http://www.cleanresources.com">www.cleanresources.com</a>                 |
| Hoffman & Lamson                | 35                    | <a href="http://www.HOFFMANandLAMSON.com">www.HOFFMANandLAMSON.com</a>             |
| United Blower                   | 37                    | <a href="http://www.unitedblower.com">www.unitedblower.com</a>                     |
| UE Systems                      | 39                    | <a href="http://www.uesystems.com/new/CA2">www.uesystems.com/new/CA2</a>           |
| Process Expo                    | 43                    | <a href="http://www.myprocessexpo.com">www.myprocessexpo.com</a>                   |

to upgrade their lubricant and improve the performance of their existing air systems.”

*Ultra EL is available in four standard sizes, including 1 liter, 5 liter, 15 liter and 208 liter drums, to meet various application needs. To learn more about the Ultra EL extended life rotary compressor lubricant from Ingersoll Rand, visit [ingersollrandproducts.com/UltraEL](http://ingersollrandproducts.com/UltraEL)*

# FREE SUBSCRIPTION

DIGITAL EDITION FREE WORLDWIDE | PRINT EDITION FREE TO U.S. SUBSCRIBERS



## COMPRESSED AIR BEST PRACTICES<sup>™</sup>

airbestpractices.com

Learn How To Save Energy & Improve  
Productivity In YOUR Industry!

### 2013 FOCUS INDUSTRIES:

- Energy: Biogas
- Food Packaging & Containers
- Plastic Blow Molding
- System Assessments
- Energy: Compressed Natural Gas
- Pneumatic Conveying
- Compressed Air System Automation
- Wastewater Treatment
- Food Processing
- Metal Fabrication & Machining
- Air Compressor Controls

Subscribe at [airbestpractices.com](http://airbestpractices.com)





# THE MARKETPLACE

## JOBS

### MANN+HUMMEL

Sales Engineers  
Application Engineers  
Product Managers

Our construction, agriculture, heavy duty and compressor business is quickly growing. If you are a Professional Sales, Application, or Product Manager, and are interested in joining our MANN+HUMMEL team please *visit our website* and apply today!

[www.Resume@Mann-Hummel.com](http://www.Resume@Mann-Hummel.com)



**MANN+HUMMEL USA, Inc.**  
6400 South Sprinkle Road Portage, MI 49002  
[www.Mann-Hummel.com](http://www.Mann-Hummel.com)

### Job & Product Marketplace Advertising Information

Reach 13,000+ readers of Compressed Air Best Practices® Magazine with Marketplace Ads every month! Job Marketplace ads are also placed for one month on [www.airbestpractices.com](http://www.airbestpractices.com) and promoted in our three monthly e-newsletters.

Ad dimensions are 2.36" wide x 3.91" tall. We can help you design the ads. Send us your logo, product photo, and text to [anna@airbestpractices.com](mailto:anna@airbestpractices.com). We recommend 20-50 total words of text.

Prices are \$300.00 per Job Marketplace Ad and \$350.00 per Product Marketplace Ad (\$300 if 6 or more ads are placed). Contact Rod Smith at [rod@airbestpractices.com](mailto:rod@airbestpractices.com) to schedule your Marketplace Ads.



Contact Rod Smith for ad rates: [rod@airbestpractices.com](mailto:rod@airbestpractices.com), Tel: 412-980-9901

### COMPRESSED AIR BEST PRACTICES® [www.airbestpractices.com](http://www.airbestpractices.com)

Advertising & Editorial: **Rod Smith**  
[rod@airbestpractices.com](mailto:rod@airbestpractices.com)  
Tel: 412-980-9901

Subscriptions & Administration: **Patricia Smith**  
[patricia@airbestpractices.com](mailto:patricia@airbestpractices.com)  
Tel: 412-980-9902

A Publication of: **Smith Onandia Communications LLC**  
217 Deer Meadow Drive  
Pittsburgh, PA 15241

Compressed Air Best Practices® is published monthly by Smith Onandia Communications LLC., 217 Deer Meadow Drive, Pittsburgh, PA 15241. Phone 412-980-9902, email [patricia@airbestpractices.com](mailto:patricia@airbestpractices.com). Compressed Air Best Practices® is a trademark of Smith Onandia Communications, LLC. Publisher cannot be held liable for non-delivery due to circumstances beyond its control. No refunds. Standard postage is paid at 100 W. Main Street, Senatobia, MS 38668. POSTMASTER: Send address changes to Compressed Air Best Practices® 217 Deer Meadow Drive, Pittsburgh, PA 15241. SUBSCRIPTIONS: Qualified reader subscriptions are accepted from compressed air professionals, plant managers, plant engineers, service and maintenance managers, operations managers, auditors, and energy engineers in manufacturing plants and engineering/consulting firms in the U.S. To apply for qualified reader subscriptions, please fill in the reader response cards herein and mail or fax or go to [www.airbestpractices.com](http://www.airbestpractices.com). To non-qualified subscribers subscriptions are \$65 in Canada and \$95 for other countries. When available, extra copies of back issues are \$4 plus shipping. Contact Patricia Smith for subscription information at Tel: 412-980-9902 or email: [patricia@airbestpractices.com](mailto:patricia@airbestpractices.com). REPRINTS: Reprints are available on a custom basis, contact Patricia Smith for a price quotation at Tel: 412-980-9902 or email: [patricia@airbestpractices.com](mailto:patricia@airbestpractices.com). All rights are reserved. The contents of this publication may not be reproduced in whole or in part without consent of Smith Onandia Communications LLC. Smith Onandia Communications LLC. does not assume and hereby disclaims any liability to any person for any loss or damage caused by errors or omissions in the material contained herein, regardless of whether such errors result from negligence, accident, or any other cause whatsoever. Printed in the U.S.A.



# THE MARKETPLACE

## TECHNOLOGY



Rebuild all brands, makes, models of Air Ends, Blowers and Gear Boxes

Sample of The PROS Company work.



Before & After

**The PROS Company**

601 Texas Avenue

Lubbock, Texas 79401

806-749-7761 (PRO1)

[www.thePROSCO.com](http://www.thePROSCO.com)

[repairyourairend@thePROSCO.com](mailto:repairyourairend@thePROSCO.com)

## Large & Custom Air Receivers



- Deal direct with the manufacturer
- ASME certified
- Internal liners & external finishes
- Inventory of popular sizes
- Ships from our central location

1-800-925-0011

[www.TIGGtanks.com](http://www.TIGGtanks.com)

Have you experienced nano?



"We get answers and support and nano stocks a tremendous amount of product. There is no doubt, if there were ever a problem, they would handle it immediately."

—Loyal distributor in the Mid-Atlantic

Experience. Customer. **Service**... n-psi

[www.n-psi.com](http://www.n-psi.com)

704-897-2182

## High Efficiency Compressor Controllers

Control Rotary Screw, Vane, Scroll or Recip Compressors



Save Energy controlling up to FOUR compressors and qualify for Utility Rebates.

- Automatic Lead/Lag Control-up to FOUR Compressors

Accurate Pressure Control with Pressure Transducers

Compressors and Vacuum Pumps from 1 to 250 hp

Thousands of Installations Worldwide. Call for Application Engineering.

**Standard Pneumatic Products, Inc.**

Tel: 203-270-1400 • Toll free: 800-979-9156

Email: [sales@stdpneumatics.com](mailto:sales@stdpneumatics.com)

[www.stdpneumatics.com](http://www.stdpneumatics.com)

## IPAC



## Air Cooled AfterCoolers

### The IPAC Advantage

- Compact
- Heavy Duty Industrial Grade Construction
- Rigid and Durable Air in/out Connections
- Flex Connections Unnecessary
- Available TEFC Motors
- Low Energy Cost
- Meets All OSHA Requirements

### Product Options

- Air Motors With Mufflers
- Low Ambient Control Packages
- Special Coatings (i.e. Corrosion Resistant)
- Alternate Materials- Tube, Fin, or Housing
- Custom Designs Available

IPAC, INC.

155 Pineview Dr. Amherst, New York 14228

1-800-388-3211 | [www.ipacinc.com](http://www.ipacinc.com)

"Your Compressed Air Treatment Specialists"

E-Mail: [mpryzak@ipacinc.com](mailto:mpryzak@ipacinc.com)



## SPVG

**SAMUEL** Pressure Vessel Group

- Stock Tanks - 12 to 5000 Gallon Available
- Custom Tanks - Up to 60,000 gallons
- Special Finishes - Galvanized / Epoxy Lined / Powder Coat & Special Paint Available
- High Pressure - Tanks Available up to 5,000 PSI
- Special Codes - CE / PED, Canadian CRN, China Code, ABS - Coast Guard, NR-13, DOT, SAE-J10 and MORE
- Great Logistics - FOB: Virginia, Wisconsin or Ontario, Canada



Call: (800) 247-8265

[www.samuelpressurevesselgroup.com](http://www.samuelpressurevesselgroup.com)

2013

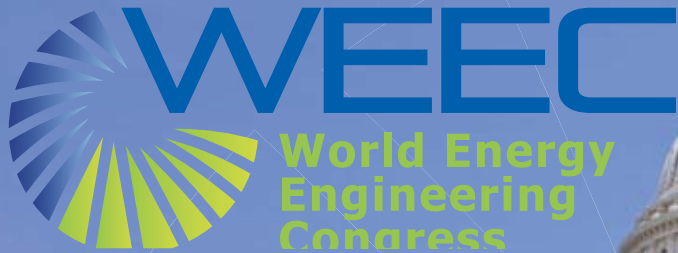

FEATURING



Sponsored By



PRESENTED BY



SEPTEMBER 25 - 27, 2013 | WASHINGTON CONVENTION CENTER | WASHINGTON, DC

## WEEC celebrating its 36th year....

The **Association of Energy Engineers (AEE)** is pleased to bring the **World Energy Engineering Congress (WEEC)** once again to Washington, DC for 2013. Now in its 36th year, the WEEC is well-recognized as the most important energy event of national and international scope for end users and energy professionals in all areas of the energy field. It is the one truly comprehensive forum where you can fully assess the "big picture" and see exactly how the economic and market forces, new technologies, regulatory developments and industry trends all merge to shape your critical decisions on your organization's energy and economic future.



### PROGRAM HIGHLIGHTS

- 13 Track Conference Program
- Expo Featuring New Technologies
- Networking Reception
- Awards Banquet
- Legends in Energy Dinner Cruise
- Seminars & Certifications
- New Technologies Breakfast
- Women in Energy Breakfast
- Chapter Luncheon Networking
- Keynote Luncheon
- FREE Exhibit Hall Workshops
- FREE Poster Sessions

SILVER SPONSOR



BRONZE SPONSORS



GREEN STAR CORPORATE ENERGY LEADER



BLUE STAR CORPORATE ENERGY LEADER



WHITE STAR CORPORATE ENERGY LEADERS



WWW.ENERGYCONGRESS.COM | 770.447.5083

kaeser.com



**KAESER  
COMPRESSORS**

*Built for a lifetime.™*

**Visit us at  
WEFTEC in  
Booth #4020**

***“The buck stops here.”***

**— Harry S. Truman**

**When it comes to service,  
Kaeser doesn't pass the buck.**

Everyone appreciates a company that stands behind its products – no matter what. That's Kaeser.

We don't just sell equipment. We help you design your system, install it, and service it. We can even monitor it for you. Our goals are the same as yours: **efficient compressed air systems you can rely on.**

Innovative technology ... ultra-reliable products ... outstanding service. It's no wonder Kaeser delivers the best value for the price! Contact us today to learn more about the powerful benefits of owning a Kaeser compressed air system.



**Kaeser Compressors, Inc. • 866-516-6888 • kaeser.com/CABP**

*Built for a lifetime* is a trademark of Kaeser Compressors, Inc. ©2013 Kaeser Compressors, Inc. customer.us@kaeser.com

Certified Management Systems

